

# METALCRAFT BENCH LATHE

---

*Universally Used in the . . .*

Home Workshop	Electric and Radio Shop
Automobile Repair Shop	Manual Training School
Manufacturing Plant	Model Shop

---

**Operating Instructions,  
List of Attachments and Parts List**

DECEMBER 1, 1933

# M E T A L C R A F T L A T H E

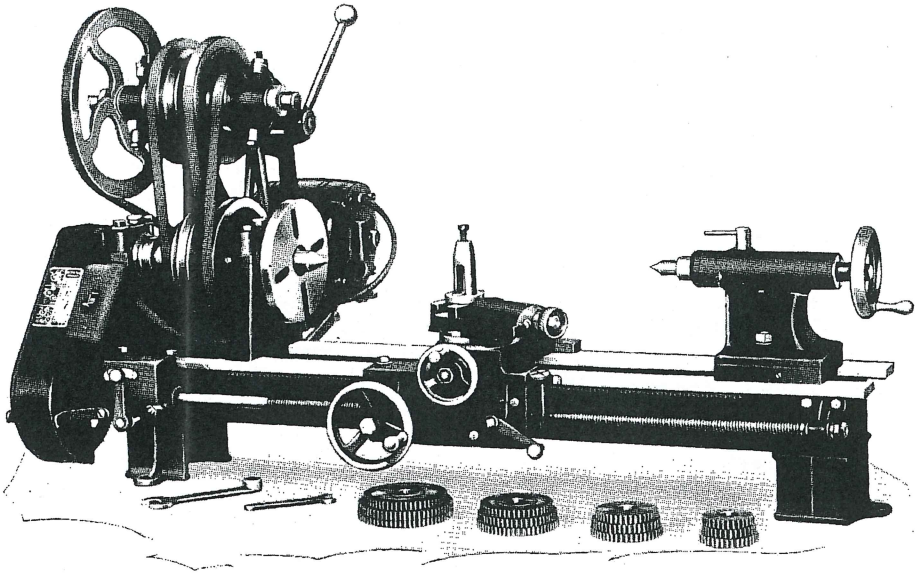

## CONTENTS

	Page		Page
Introduction .....	3	Belt Tension .....	6
The Home Workshop .....	3	Facing .....	7
Automobile Repair Shop .....	3	Turning Long Work—the Steady Rest	7
Manufacturing Plant and Machine		Boring .....	7
Shop .....	3	Cutting Off .....	7
Electric and Radio Shop.....	3	Taper Turning .....	8
Commercial Model Shop .....	3	Knurling .....	8
Manual Training and Vocational		Thread Cutting .....	8
School .....	3	Universal Chuck .....	9
Setting Up the Lathe.....	4	Compound Rest .....	10
Parts of the Lathe.....	4	Carriage Stop .....	10
Locating Centers .....	5	Wood Turning .....	10
Centering Work in a Chuck.....	5	Conclusion .....	10
Cutting Tool Bits.....	6	Lathe Specifications .....	11
Sharpening Tools .....	6	Attachments .....	12, 13, 14
Angle of Tool to Work.....	6	Parts List .....	15, 16, 17, 18, 19
Cutting Speeds .....	6	Decimal Equivalents .....	20
		Don'ts for Machinists .....	20

# INTRODUCTION

The lathe has been justly termed the "Heart of the Workshop". It possesses greater versatility than any other machine—practically every machining operation can be performed on a lathe. For this reason it is the most universally used and universally useful item of equipment in any shop—large or small.

Because of its versatility, a lathe is the ideal machine for the **home workshop**. Many home craftsmen make their lathe pay for all the equipment in the shop. The market for small models and mechanical appliances is tremendous. Why not let this market pay for your equipment—and besides provide spending money for yourself? Besides original construction, a great deal of repair work can be done on your own car, truck, tractor, or home appliances, with a lathe.

In the **automobile repair shop** countless money saving and profit making jobs can be performed on a lathe—turning armatures, making bushings, boring bearings, truing valves, facing plates, yokes, etc. With the compound rest, valves of any angle can be faced. These jobs, plus all the regular turning and thread cutting operations that so often are sent out to a better equipped shop, make the lathe a profitable investment for any garage.

Every **manufacturing plant and machine shop** should have at least one of these lathes. Its convenient size and ready adaptability make it ideal for the experimental laboratory, maintenance department, tool room, or production bench. No line shafting power is required—the lathe is a complete unit in itself. Set it up anywhere—plug the cord in a lamp socket and it is ready to go.

The **electric or radio shop** will find many uses for a lathe—making motor pulleys or bushings, turning armatures, etc. Frequently there is a need for a dial or knob of peculiar size or shape. This sort of thing can be splendidly done on a lathe. A few special operations such as this, besides the regular duties of a lathe, will soon make it pay for itself in time saved and increased versatility of the shop.

For the **commercial model shop, patent attorney's laboratory**, and the like, the convenient size and economical running cost of this lathe render it invaluable. Its capacity is great enough to handle all work ordinarily encountered, yet the whole assembly may be set up on a bench, out of the way. Complete wood working equipment is available. The rigid stability and accuracy of this lathe make it a splendid machine for use in the construction of delicate models.

**Vocational and manual training schools** everywhere have hesitated about installing a number of lathes only because of their heretofore prohibitive cost. Here is an answer to that demand. A real lathe, constructed of the finest materials by skilled mechanics, offered at a price within the reach of everybody.

See this lathe—watch it run if possible. Examine the fine, workman-like parts that make it turn out work more accurately than has been dreamed of in an inexpensive lathe up to now. Notice particularly the Vee belt drive—the most modern method of transporting power—that elim-

inates the necessity for complicated back gearing. With this type of drive the speeds are changed rapidly and simply with the power OFF. This is an added safety factor that means much, especially if inexperienced operators are running the lathe. There is little chance of catching a finger or part of one's clothing in these belts. Compare the lathe and all it offers with any other at anywhere near the same price—and then decide.

**The Workshop.** There are three natural factors to consider before choosing the location of the workshop—humidity, temperature, and lighting. These are relatively simple, yet they are important if the shop is to operate at maximum efficiency. A little careful thought in selecting the most suitable location will be rewarded by increased ultimate efficiency.

The bench upon which the lathe is mounted should be of solid construction to avoid possible vibration. Two inch planking is generally used for the top, supported by good, solid legs. Make it large enough to hold all tools without crowding. Arrange everything systematically and keep your tools in their places. Bolt all power driven tools to the bench.

**Parts of a Modern Lathe.** Fig. 1 shows the parts of a modern lathe. Study this; use it as a reference while reading the following directions.

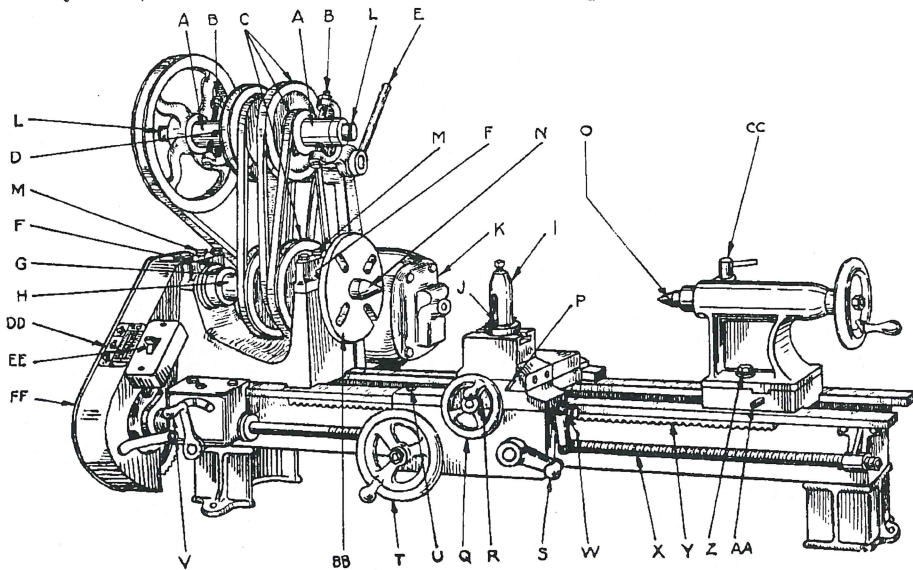

Fig. 1. PARTS OF A MODERN LATHE

- A—Countershaft Bearing
- B—Countershaft Adjusting Screw
- C—Compound Drive Pulleys
- D—Clutch Shift Collar
- E—Belt Tension Lever
- F—Spindle Bearings
- G—Spindle Thrust Washer
- H—Spindle
- I—Tool Post
- J—Tool Post Rocker
- K—Motor
- L—Countershaft Grease Cups
- M—Spindle Bearing Oil Cups
- N—Headstock Center (live)
- O—Tailstock Center (dead)
- P—Cross Feed Gib.

- Q—Cross Feed Hand Wheel
- R—Micrometer Collar on Cross Feed Screw
- S—Half Nut Lever
- T—Carriage Hand Wheel
- U—Carriage Lock
- V—Reverse Gear Lever
- W—Threading Dial
- X—Lead Screw
- Y—Carriage Rack
- Z—Tailstock Lock Nut
- AA—Tailstock Set-over Screw
- BB—Face Plate
- CC—Tailstock Spindle Lock
- DD—Threading Chart
- EE—Motor Switch
- FF—Gear Guard Cover

# OPERATING INSTRUCTIONS

**LOCATING CENTERS.** There are several ways of finding the centers of the work. Probably the easiest method, and the one most generally used, is illustrated in Fig. 2.

An ordinary pair of spring dividers are used. Hold one point of the dividers against the edge of the stock and draw four lines as shown. Make a prick punch at the center of the enclosure formed by these lines.

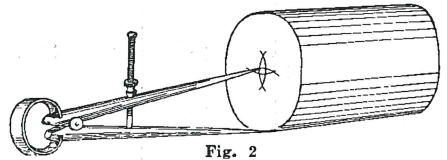

Fig. 2

Test centers by hand revolving the work between lathe centers and marking high spots with chalk. When you are sure the centers are correct they must be drilled and countersunk. If a drill press or centering machine is not at hand, use a centering tool. Place this in the collet or drill chuck in the live center of the lathe and run the work to be centered against it until it is drilled and countersunk to the proper depth. Repeat this for both ends. The work is now ready to be turned. Improper centering will destroy the lathe centers. These centers should be carefully taken care of as upon them depends to a large extent the accuracy of the lathe. Keep the tailstock center points well lubricated at all times with one of the lathe center lubricants on the market or with a mixture of oil and white lead. Before placing the work on the centers, slip a lathe dog on one end. Make sure the dog is sufficiently large not to touch the center of the face plate, (See illustration) as tension here tends to push the work off center. Adjust the tailstock so that there is no end play between centers yet so that the work is free to turn.

**CENTERING WORK IN A CHUCK.** The independent, four jaw chuck will be found the most satisfactory type for most work. Centering work in a

chuck of this sort, first place it so that it seems about in the center. Run the lathe at a moderate speed and test the centering by holding a piece of chalk so that it touches only the high spots. Readjust the chuck until the chalk touches evenly all the way around. Before putting a chuck on a lathe spindle, always remember to clean the threads of both the chuck and the spindle.

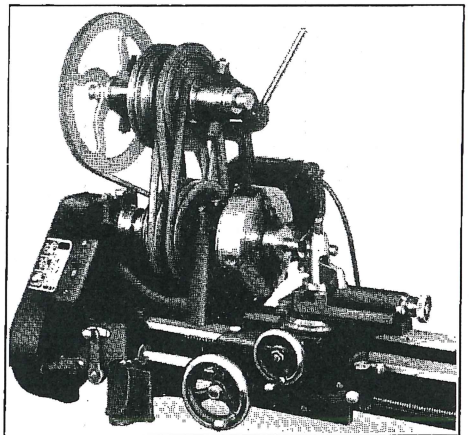

Fig. 3

**Remember:** A few extra minutes spent in carefully starting work may save hours and valuable material later.

**CUTTING TOOL BITS.** There is not enough space here to describe all the different kinds and shapes of cutting tools and their uses. It is wise if the unskilled purchase already formed tools for the particular operations he wishes to perform. Tool bits are not expensive and the purchase of a set of these will probably prove the cheapest and most satisfactory way out in the long run.

**SHARPENING TOOLS.** Keep your cutting tools sharp at all times. This is essential if good, clean work is to be done. A dull tool will leave a jagged, untrue piece of work. Sharpen the tools on a grinding or emery wheel and finish with an oil stone. Do most of the grinding on the top of the tool to retain the original shape as much as possible. Be sure the tool is ground with clearance so that only the cutting edge will touch the work. Be careful not to heat the tool so that it loses its temper. It is a good idea to have a skilled mechanic help grind your tools until you are familiar with the operation.

**ANGLE OF TOOL TO WORK.** The angle of the cutting tool to the work varies according to the hardness of the metal being cut. The accompanying drawings (Figs. 4 to 6) show in general the proper angles to be used for the different classes of metals. Refer to these drawings before taking a cut until you are sure you know the proper angle for each metal.

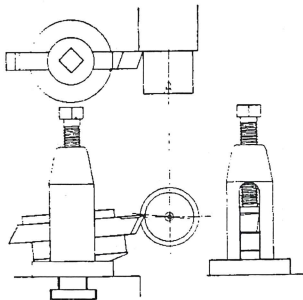

Fig. 4—Cutting Mild Steel or Cast Iron

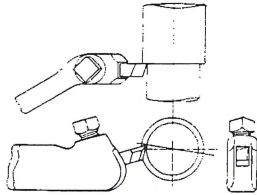

Fig. 5—Cutting Carbon Steel

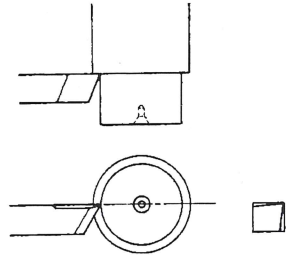

Fig. 6—Cutting Brass or Soft Metals

**CUTTING SPEEDS.** The speed a cut is taken varies according to the kind of metal being cut and the kind of cut—whether roughing or finishing. Brass may be cut faster than steel and a light cut faster than a heavy one. To change speeds; pull release lever “E”, Fig. 1, toward front, arrange belts on cone pulleys to desired speed. Sliding collar “D” to right engages compound drive mechanism, to left, direct drive. Slowest speeds are in compound drive.

**BELT TENSION.** It will be noticed that there are two flat spots on the cam of the belt tension lever. For ordinary work the first step gives sufficient tension. When more power is necessary, for taking heavy cuts, the belts may be tightened by pushing the lever back to the second step.

**FACING.** Before starting a facing operation, it is wise to clamp the carriage to the bed, unless a carriage stop is used. This prevents it from moving away from the work. Arrange the cutting tool as shown in Fig. 7, so that the cutting edge is the only part that can touch the work throughout the operation. Note that the point reaches the work at just about the center, and at an angle of between 30 and 45 degrees. Feed the tool from the center toward the outside diameter. Take light cuts.

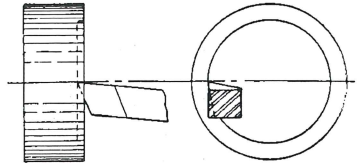

Fig. 7

**TURNING LONG WORK—The Steady Rest.** When turning long work, especially of small diameter, it is necessary to support it along its length. For this purpose a steady rest is essential. (See Fig. 8.) Before placing this steady rest in position, locate the work between centers and turn lightly a concentric spot where the rest is to be placed. Now locate the steady rest, clamping it to the bed, and turn the screws down until they just touch the work. **Make sure there is no excessive pressure.** Too great a pressure on the jaws causes heating and resultant scoring of the work.

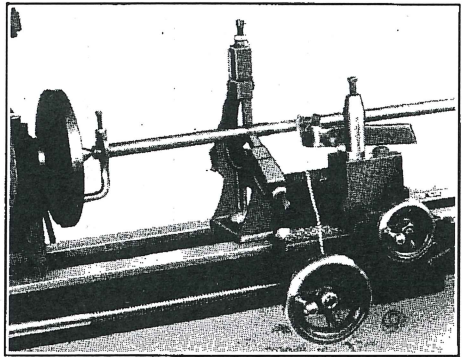

Fig. 8

**BORING.** For boring, and all inside work, a special tool is used. (See Fig. 9.) This tool should be set in the tool holder parallel to the lathe bed, the point just below center of the work and at a slight upward angle. Because of the tendency boring tools have to spring, light cuts should be taken, especially as the finished size is approached. Sometimes a straighter hole is bored if the tool is fed in both directions—in and out. It is always good policy when boring on a lathe to caliper the work often.

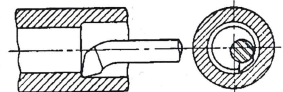

Fig. 9

**CUTTING OFF.** For cutting off, a special tool (See Fig. 10) is used. This tool is relieved from the back with the maximum width at the cutting edge to insure proper clearance throughout the operation. The tool must be set exactly at the center of the work and solidly clamped in the tool post. Take the size cut that seems to work the best; too light cuts may result in chattering while cuts that are too heavy will jam the lathe and very likely break the tool. The proper depth of this cut and the speed of the lathe depend, of course, upon the material of the work. When the work has been severed, finish off the ends with a facing tool.

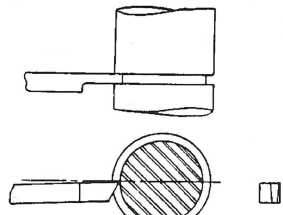

Fig. 10

**TAPER TURNING.** Taper is expressed by the difference in diameter per unit length;  $\frac{1}{2}$ " per foot, etc. To turn a taper of given dimension, move the tailstock off center, by means of screws provided for this purpose, **half** the amount of taper desired. For example: given a piece of round stock 12" long; taper desired,  $\frac{1}{2}$ " to 1 foot. Move the tailstock  $\frac{1}{4}$ " off center, place the work between the lathe centers and proceed with the turning operation in the usual manner. To check taper for accuracy, reduce to taper per inch; for example:  $\frac{1}{2}$ " to 1 foot is the same as .04166" to 1 inch. Take a light cut and check with micrometer to see if proper amount of taper is present. Readjust tailstock to correct any error. For taper turning the tool must be as near center as possible.

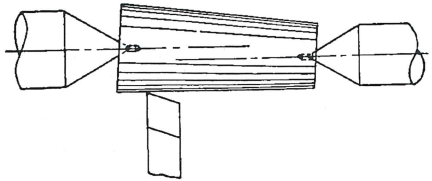

Fig. 11

**KNURLING.** Occasionally it is desired to knurl a handle, etc., on a lathe. For this purpose a special knurling tool (See Fig. 12) is used. Place this tool in the tool post and run it up against the work as near the center as possible. Start on the right end. Force the tool into the work slightly, set the longitudinal feed, and let it feed across the work. Do not remove the tool, but force it into the work a little more and let it feed back to the starting point. Repeat this process until knurling is finished. Use plenty of oil on the tool during the operation.

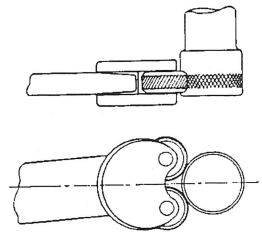

Fig. 12

**THREAD CUTTING.** After some practice, threads of any description can be cut on this lathe. The following explains only the U.S.S., or National Coarse Thread, as this is the most common. To cut accurate threads, it is of primary importance that the cutting tool be ground to the proper angle. For this purpose a thread gauge of the type shown in Fig. 13 is employed. Place the gauge along the work as shown and run the tool into the triangular notch. Inaccuracies can be immediately detected and remedied. The point of the tool should be exactly at the center of the work. (See Fig. 14.) Consult feed chart for proper gear arrangement. See that the threading dial is in mesh. Before starting to cut a thread read the following carefully: Cutting any

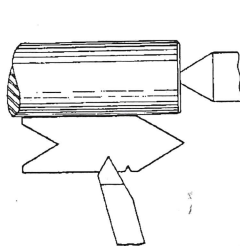

Fig. 13

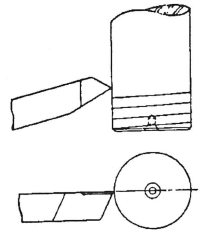

Fig. 14



even thread, engage the feed lever with the line on the carriage corresponding to **any** line on the threading dial; for cutting odd threads, use either of the **numbered** lines on the dial; for cutting half threads, use one of the numbered lines, but be sure to use the **same number** for each cut. If the above directions are not followed carefully the result will be a split thread. It is a good idea after the first cut has been made to measure the number of threads per inch as a final check. (See Fig. 16.) If everything is found to be correct go ahead with the cutting until the proper depth is reached. This is best determined by actually trying the nut on the thread.

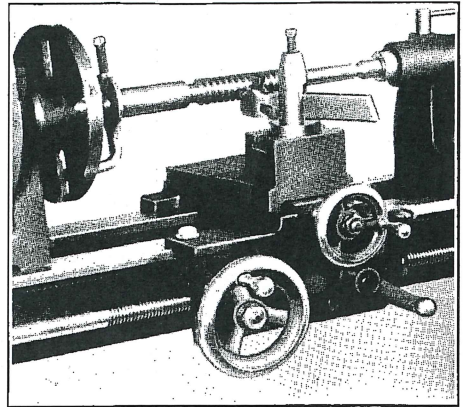

Fig. 15

Inside threads are cut in much the same manner except that an inside threading tool must be used. First of all caliper the hole to be sure that it is absolutely true. Test the angle of the threading tool in the manner shown in Fig. 17. The same rules apply for inside threading that apply to boring. Light cuts must be taken because of the tendency of the tool to spring. The tool should be used parallel to the lathe bed and as near the center of the work as possible. Threading tools are kept on center to insure a properly angled thread.

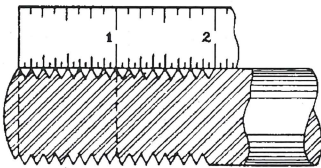

Fig. 16

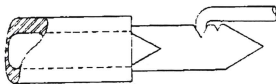

Fig. 17

**THREADING CHART**

SPINDLE POSITION "A"

POSITION "B"

THREAD	SPINDLE	CRANK	CRANK	CRANK	CRANK
NO. IN	NO. IN	PLUG	PLUG	PLUG	PLUG
1	30	..	..	..	..
2	15	..	..	..	..
3	10	..	..	..	..
4	7 1/2	..	..	..	..
5	6	..	..	..	..
6	5	..	..	..	..
7	4 1/2	..	..	..	..
8	3 3/4	..	..	..	..
9	3	..	..	..	..
10	2 2/3	..	..	..	..
11	2 1/4	..	..	..	..
12	2	..	..	..	..
13	1 3/4	..	..	..	..
14	1 1/2	..	..	..	..
15	1 1/3	..	..	..	..
16	1 1/4	..	..	..	..
17	1 1/5	..	..	..	..
18	3/4	..	..	..	..
19	2/3	..	..	..	..
20	1/2	..	..	..	..
21	1/2	..	..	..	..
22	1/2	..	..	..	..
23	1/2	..	..	..	..
24	1/2	..	..	..	..
25	1/2	..	..	..	..
26	1/2	..	..	..	..
27	1/2	..	..	..	..
28	1/2	..	..	..	..
29	1/2	..	..	..	..
30	1/2	..	..	..	..
31	1/2	..	..	..	..
32	1/2	..	..	..	..
33	1/2	..	..	..	..
34	1/2	..	..	..	..
35	1/2	..	..	..	..
36	1/2	..	..	..	..
37	1/2	..	..	..	..
38	1/2	..	..	..	..
39	1/2	..	..	..	..
40	1/2	..	..	..	..
41	1/2	..	..	..	..
42	1/2	..	..	..	..
43	1/2	..	..	..	..
44	1/2	..	..	..	..
45	1/2	..	..	..	..
46	1/2	..	..	..	..
47	1/2	..	..	..	..
48	1/2	..	..	..	..
49	1/2	..	..	..	..
50	1/2	..	..	..	..
51	1/2	..	..	..	..
52	1/2	..	..	..	..
53	1/2	..	..	..	..
54	1/2	..	..	..	..
55	1/2	..	..	..	..
56	1/2	..	..	..	..
57	1/2	..	..	..	..
58	1/2	..	..	..	..
59	1/2	..	..	..	..
60	1/2	..	..	..	..

COPYRIGHT 1910 BY THE NATIONAL MACHINE TOOL WORKS CO. NEW YORK, N. Y.

Fig. 18

**UNIVERSAL CHUCK.** (See Fig. 19.) This Chuck was developed especially for use on this lathe. It is threaded to fit the spindle and capably replaces expensive draw-in collets. With it small diameters from 1/8" to 5/8" can be mounted in the lathe and turned, etc.

**COMPOUND REST.** (See Fig. 19.) With a compound rest the cutting tool may be fed to the work at any angle. This makes possible the cutting of tapers beyond the range of the regular taper attachment. This type rest is also of valued assistance in thread cutting. For cutting U.S.S. thread, for example, set the rest at 29 degrees. Grind and set the tool in the usual manner and run it up to the work with the cross slide screw. Mark a line across the dial on screw with chalk and return feed screw to this line after each cut. Do feeding in with the compound rest. In this method the cutting tool cuts on only one side and produces a cleaner thread. There is also less chance of chipping off end of cutting tool.

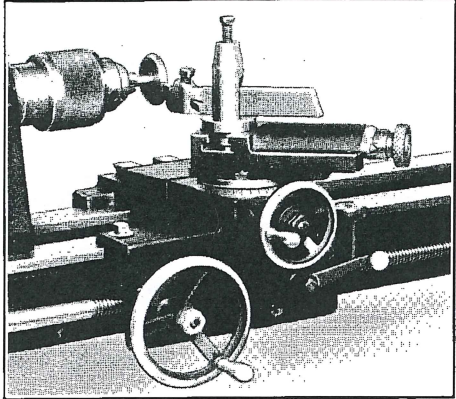

Fig. 19

The compound rest listed on our accessory page is especially built for use on this lathe. It is graduated in thousandths of an inch for precision work.

**CARRIAGE STOP.** This stop is particularly useful for facing operations where absolute accuracy is required. Micrometer graduated. To use: Take a light truing cut on the work to be faced, set the stop against the carriage and clamp it in position. Now adjust the micrometer exactly the amount of stock it is desired to remove, run the carriage against the stop and start the cutting. Precision is assured. **Don't run carriage against stop with power feed on.**

**WOOD TURNING.** A metal working lathe is especially well adapted to wood turning because of the additional accuracy and rigidity that is necessarily present in a machine of this kind. All that is necessary to make an excellent wood working machine of this lathe is the addition of a small amount of inexpensive equipment. (See accessories.) To turn wood: locate the piece to be worked between special centers, locate the hand tool rest in position, run the lathe at fast speed with special pulleys, and holding the chisel in the right hand with the left used as steadier, turn the work to desired size or shape. Unless automatic feeds are required, the feed gears should be disconnected from the spindle.

**CONCLUSION.** Without doubt some prospective owners have never had the opportunity to run a lathe. This fact should not deter him from obtaining one if it is possible. The fascinating as well as lucrative operations that can be performed on this machine make it an investment never to be regretted. It is not difficult to learn to run a lathe. With some practice, anybody can become an expert operator. In the preceding pages we have attempted to describe the various operations in the simplest manner so that the beginner can start to do real work as

soon as the machine is set up. Do not be discouraged if at first your work is not all you had hoped for. Every machinist knows that some amount of practice is necessary before precision work can be turned out. Although the fundamental directions have all been included in this manual, remember that no written instruction can take the place of actual practice on the lathe itself. There are a number of splendid instruction books—far more complete than this—on the market, but by just “sticking to” experimenting on your machine, you will gain more information than any book will ever give you.



## SPECIFICATIONS

Swing over Bed .....	9"
Swing over Carriage .....	6"
Capacity between Centers .....	18" to 36"
Length of Bed .....	36" to 54"
Headstock Spindle—Hollow, $\frac{3}{4}$ " hole; $1\frac{1}{2}$ " diam., 8 U.S.F. threads; nose has No. 3 Morse taper, with reducing sleeve to take No. 2 taper center.	
Tailstock Spindle— $2\frac{3}{4}$ " travel; $\frac{1}{2}$ " set over for taper turning; nose has No. 2 Morse taper.	
Speeds in Direct Drive.....	220 - 370 - 600
Speeds in Compound Drive.....	47 - 80 - 130
Lead Screw .....	8 Acme threads per inch
Feed per Revolution .....	.0087" or .0055"
Thread Cutting Range.....	4 to 72 per inch
Size of Tool Holder .....	$\frac{3}{8}$ " x $\frac{7}{8}$ "

### MILLING ATTACHMENT

This sturdily constructed attachment when attached to the Metalcraft, does all the work of a small milling machine. It is put in place very simply by removing the Compound Rest and attaching the Milling Attachment Base to two screws provided. The cutters may be held in a Headstock Chuck, special Holding Attachment listed, or in the Headstock Taper.

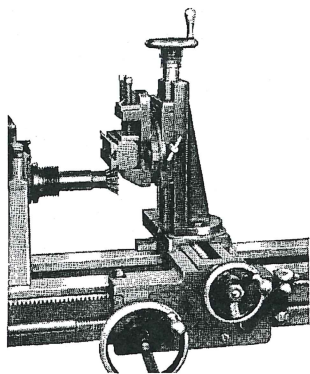

Operating View  
No. 8073

### TOOL POST GRINDER

With the Metalcraft Tool Post Grinder it is possible to grind Valves, Pistons, Centers, Bushings, Reamers, etc., as well as do mica undercutting on armatures. A novel raising screw makes this last job possible, and also adapts the Grinder to any Lathe. Grinder is furnished with 1/8 H.P. Universal Motor, Diamond Dresser, 1 Internal Grinding Wheel, 1 External Grinding Wheel, 5 Undercutting Saws, and the necessary belts, pulleys, etc.

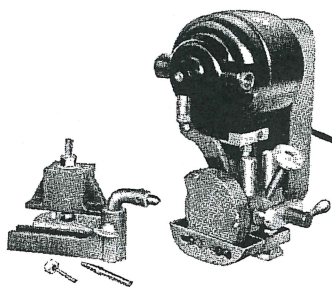

No. 8078

### SPECIAL WOODWORKING ATTACHMENT

Although excellent work can be done with wood with the regularly furnished Metalcraft equipment, it is recommended that the attachments listed here be purchased if any appreciable amount of this type of work is to be done. The Special Pulleys are combination for metal or wood turning and give a range of speeds for metal of 47 to 690 R. P. M., and for wood of 130 to 1625 R. P. M. Complete set consists of two Hand T-Rests with Bracket, two-step pulley set, Cup Center, spur center and screw center.

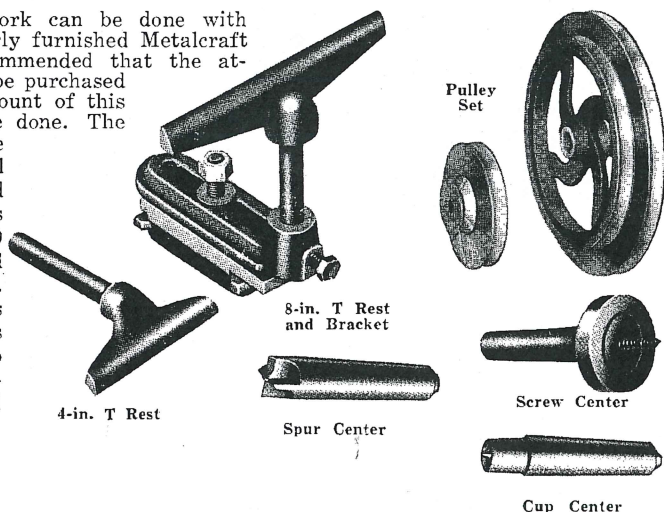

No. 8079

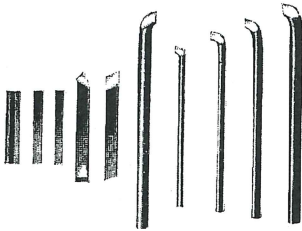

Complete Set Tool Post High Speed Cutting Tools and Spacers, including 5 Boring Tools; 1  $\frac{3}{8}$ " Turning Tool; 1  $\frac{3}{8}$ " Threading Tool; 3 Spacers.

No. 6719

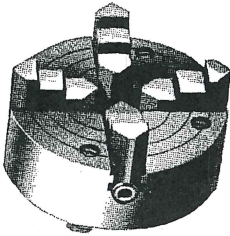

4-Jaw Independent Chuck with Adapter Plate  
6" Capacity  
No. 6712

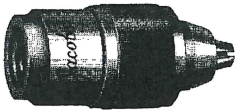

Universal Chuck with Adjusting Wrench  
Threaded to fit Headstock Spindle  
No. 6713

Special Arbor to adopt No. 6713 or 8071 to Tailstock  
No. 6714



**6 FORMED TOOL BITS**

High speed steel, ready for use. Set includes left and right hand turning tool, left and right hand facing tool, round nose and threading tool, all  $\frac{1}{4}$ " size.

No. 6888



**TOOL HOLDERS**

High grade steel forging, carefully machined and finished. Hold  $\frac{1}{4}$ " tool bits. Shpg. wt., each, 12 oz. Not Prepaid.

- 6717—Offset, Right
- 6889—Offset, Left
- 6890—Straight
- 6891—Threading
- 6892—Cut-off

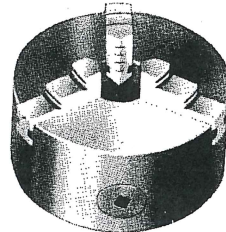

**5" UNIVERSAL 3-JAW CHUCK**

For holding round and hexagonal work. Jaws move simultaneously. Complete with 2 sets of jaws and adapter plate ready to fit spindle nose.

No. 6932

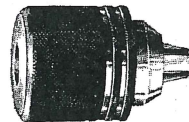

**ADJUSTABLE BEARING CENTER REST CHUCK**

Fits on tailstock and holds centerless armatures. Capacity  $\frac{3}{8}$ " to  $\frac{3}{4}$ ".

No. 8071

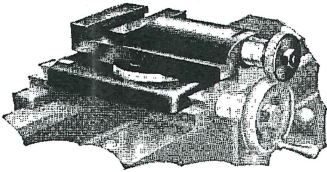

Compound Rest  
Graduated to 180 degrees  
No. 6711

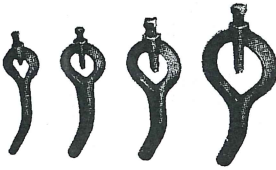

Drop Forged Lathe Dogs  
Set of Four  $\frac{1}{2}$ " to  $1\frac{1}{2}$ "  
No. 6720

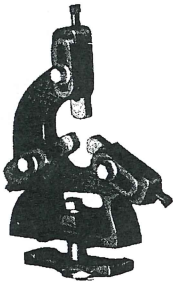

**STEADY REST**  
Necessary for turning long shafts  
of small diameter  
No. 6715

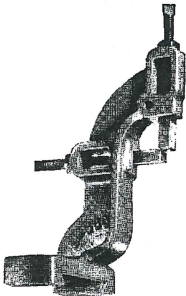

**FOLLOWER REST**  
Fastens to carriage and follows  
the cutting tool. Practically a necessity  
for long work of small diameters.

No. 8070



Knurling Tool  
with one set of knurls  
No. 6718



Crotch Center  
No. 6726



Drill Pad  
No. 6722

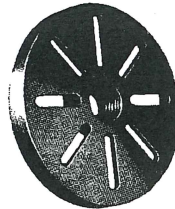

**FACE PLATE**  
 $8\frac{1}{2}$ " diameter. Shpg. wt., 6 lbs.  
No. 6716

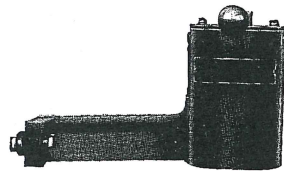

**REVERSING SWITCH**  
Permits rotation of the lathe  
spindle in either direction. Complete  
with mounting bracket.

No. 8072

# Repair Parts List

---

## IMPORTANT

### Special Instructions for Ordering Parts

---

All repair parts listed on pages 16, 17, 18 and 19 **MUST** be ordered on a *separate order blank*, separate and apart from other merchandise.

*Mail these orders to*

**SEARS, ROEBUCK & CO.**

1851 N. Pitcher St., KALAMAZOO, MICH.

---

Accessories listed on pages 12, 13 and 14 should be ordered from your nearest SEARS, ROEBUCK & CO. Mail Order Store.

M E T A L C R A F T L A T H E

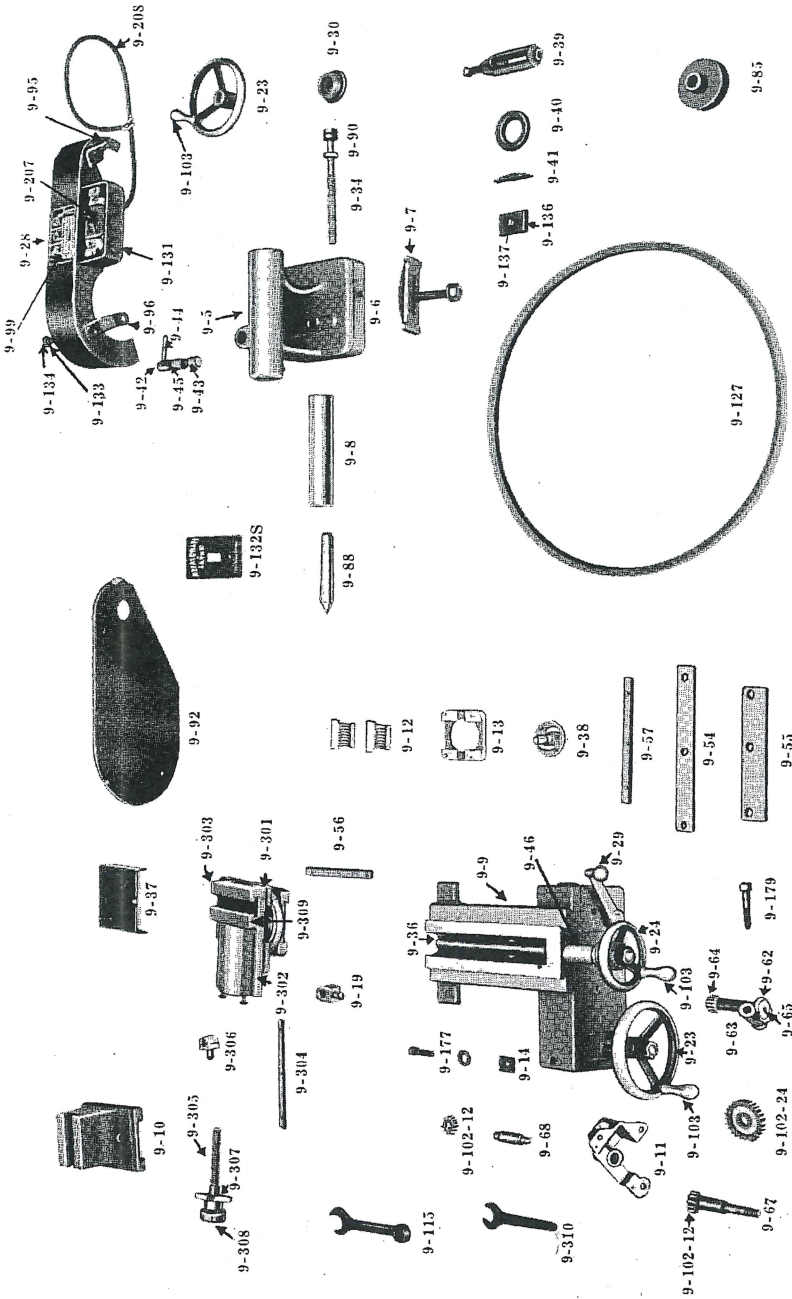



# P A R T S L I S T

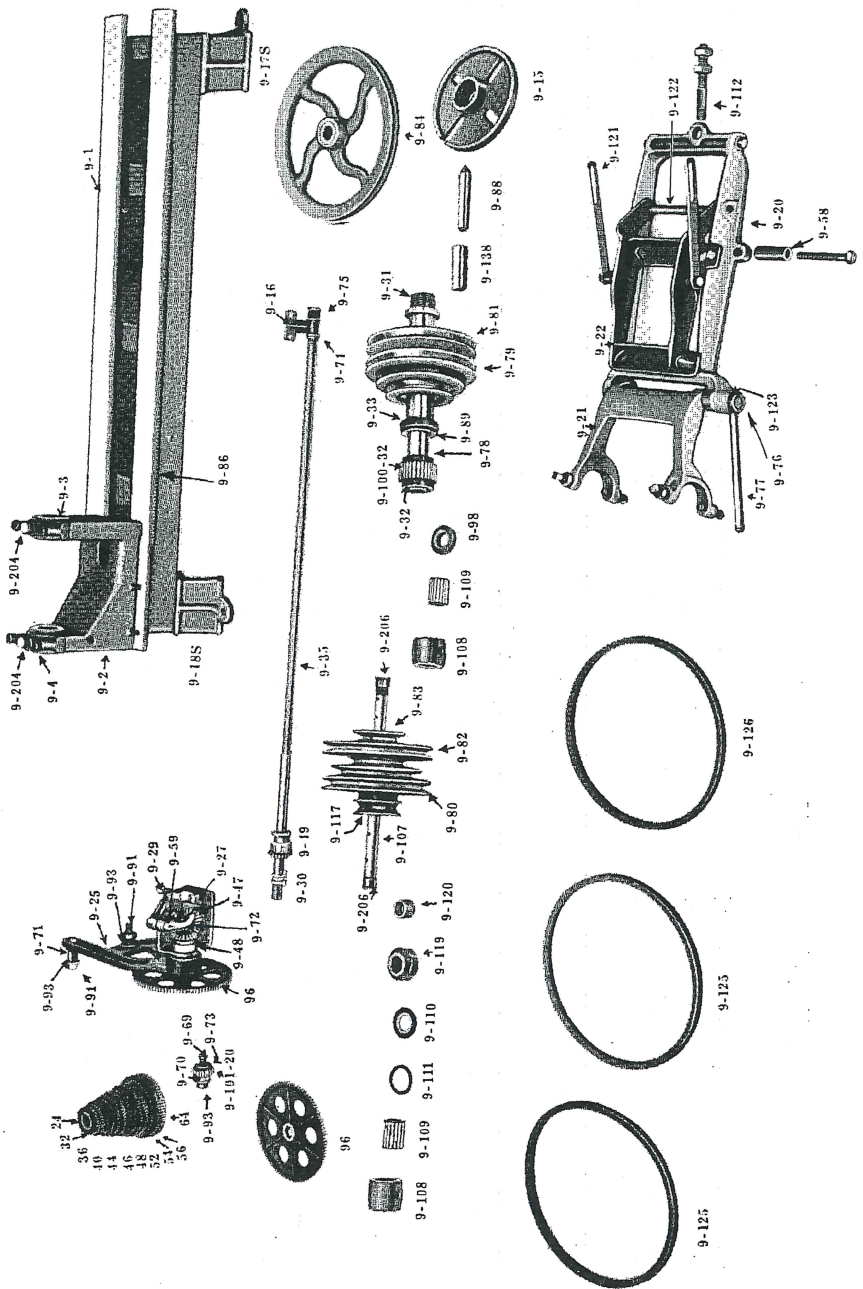

# M E T A L C R A F T L A T H E

Part No.	Name	Price	Part No.	Name	Price
9-1	36" Bed	\$17.50	9-56	Cross Feed Gib	.20
9-1-42	42" Bed	24.50	9-57	Carriage Gib	.20
9-1-48	48" Bed	32.50	9-58	Ctr. Shaft Bracket Spacer	.10
9-1-54	54" Bed	39.50	9-59	Rev. Shift Yoke	.40
9-2	Head Stock	9.50	9-60†	Rev. Lever Plunger	.15
9-3	Head Stock Cap (Right)	.80	9-61†	Rev. Lever Plunger Spring	.10
9-4	Head Stock Cap (Left)	.80	9-62	Threading Dial	.30
9-5	Tail Stock	4.50	9-63	Threading Dial Body	.35
9-6	Tail Stock Base	2.50	9-64	Threading Dial Gear	.30
9-7	Tail Stock Clamp	.35	9-65	Threading Dial Shaft	.20
9-8	Tail Stock Ram	4.00	9-66†	Split Nut Stud	.10
9-9	Carriage	8.50	9-67	Hand Wheel Shaft	.60
9-10	Carriage Slide	3.75	9-68	Carriage Pinion Shaft	.40
9-11	Carriage Gear Case	.80	9-69	Change Gear Idler Bolt	.10
9-12	Split Nut	.70	9-70	Comp. Gear Bushing	.35
9-13	Split Nut Guide	.70	9-71	Idler Gear Bushing	.35
9-14	Carriage Clamp	.40	9-72	Feed Screw Rev. Driver Stud	.45
9-15	Face Plate (Small)	2.50	9-73	Comp. Gear Driver Stud	.40
9-16	Feed Screw Bearing	.30	9-74	Feed Screw Thrust Washer (L)	.20
9-19	Carriage Slide Nut	.90	9-75	Feed Screw Thrust Washer (R)	.20
9-20	Countershaft Bracket	1.60	9-76	Rocker Shaft	1.30
9-21	Countershaft Hanger	1.30	9-77	Rocker Shaft Handle	.50
9-22	Motor Base	.75	9-78	Spindle Gear Spacer	.40
9-23	Hand Wheel (Large)	1.40	9-79	3-Step Cone V Pulley (Spindle)	3.25
9-24	Hand Wheel (Small)	1.40	9-80	3-Step Cone V Pulley (Ctr. Shaft)	3.25
9-25	Change Gear Bracket	1.00	9-81	2-Step Idler V Pulley (Spindle)	2.75
9-26†	Reverse Gear Case Bushing	.40	9-82	V Belt Pulley (Comp. Clutch)	2.25
9-27	Reverse Gear Case	3.50	9-83	V Pulley (Comp. Driver)	1.50
9-28	Change Gear Guard	1.20	9-84	V Countershaft Dr. Pulley	3.00
9-29	Split Nut & Reverse Lever	.35	9-85	V Motor Shaft Pulley	.65
9-30	Tail Stock Screw Bearing	.35	9-86	Carriage Rack for 36" Bed	2.25
9-31	Head Spindle	8.00	9-86-42	Carriage Rack for 42" Bed	2.65
9-32	Head Spindle Collar (L)	.35	9-86-48	Carriage Rack for 48" Bed	2.95
9-33	Head Spindle Collar (R)	.40	9-86-54	Carriage Rack for 54" Bed	3.45
9-34	Tail Stock Ram Screw	.75	9-88	Center No. 2 Morse Taper	1.00
9-35	Feed Screw for 36" Bed	2.50	9-89	Spindle Thrust Washer	.35
9-35-42	Feed Screw for 42" Bed	3.50	9-90	Ram Screw Thrust Washer	.15
9-35-48	Feed Screw for 48" Bed	4.60	9-91	Change Gear Bracket Stud	.25
9-35-54	Feed Screw for 54" Bed	5.90	9-92	Change Gear Guard Cover	.45
9-36	Carriage Slide Screw	.80	9-93	Change Gear Washer	.10
9-37	Carriage Slide Guard	.30	9-94†	Change Gear Br. Stud Nut	.15
9-38	Split Nut Scroll	.25	9-95	Change Gear Guard Lug (Top)	.10
9-175	Bench Leg (R)	.75	9-96	Change Gear Guard Lug (Bot.)	.10
9-185	Bench Leg (L)	.75	9-97†	Head Stock Clamp	.35
9-39	Tool Post	1.40	9-98	Ctr. Shaft Collar	.35
9-40	Tool Post Washer	.25	9-99	Threading Chart	.25
9-41	Tool Post Rocker	.20	9-100-32†	Spindle Gear	.70
9-42	Ram Lock Nut	.30	9-101-20	Feed Gear	.20
9-43	Ram Lock Screw	.30	24	Change Gear	.50
9-44	Ram Lock Handle	.20	32	Change Gear	.50
9-45	Ram Lock	.25	36	Change Gear	.35
9-46	Carriage Slide Screw Bearing	.50	40	Change Gear	.45
9-47	Feed Screw Reverse Idler Gear	.30	44	Change Gear	.45
9-48	Feed Screw Reverse Gear (Left)	.60	46	Change Gear	.50
9-49	Feed Screw Reverse Gear (Right)	.60	48	Change Gear	.50
9-50	Reverse Shift Collar	.15	52	Change Gear	.55
9-51†	Feed Screw Driver Washer	.10	54	Change Gear	.55
9-52†	Feed Screw Gear Stub	.40	56	Change Gear	.55
9-53†	Feed Screw Left Rev. Gear Wash.	.10	64	Change Gear	.80
9-54	Carriage Bearing Plate (Front)	.30	96	Change Gear	1.25
9-55	Carriage Bearing Plate (Rear)	.30	9-102-12	Carriage Traverse Gear	.25

**Order all REPAIR PARTS direct from Sears, Roebuck and Co.,  
1851 No. Pitcher St., Kalamazoo, Mich.**

# P A R T S L I S T

Part No.	Name	Price	Part No.	Name	Price
9-102-24	Carriage Traverse Gear	.20	9-186†	3/8-16x2-1/2 Machine Bolt Less Nut	.05
9-103	Carriage Wheel Handle	.20	9-187†	3/8-16x1-1/2 Square Head Set Screw	.20
9-107	Ctr. Shaft Spindle	1.25	9-188†	1/4-20 Check Nut	.05
9-108	Ctr. Shaft Bearing Race	.60	9-189†	3/8-16 Nut	.05
9-109	Ctr. Shaft Roller Bearing	.60	9-190†	3/8-16 Jam Nut 3/16 thick	.05
9-110	Ctr. Shaft Roller Ret. Wash.	.60	9-191†	1/2-13 Check Nut	.05
9-111	Ctr. Shaft Roller Ret. Wash. (Felt)	.10	9-192†	5/16 Washer	.05
9-112	Ctr. Bracket Stud	.25	9-195†	7/16 Washer	.05
9-113†	Feed Screw Gear Spacer	.30	9-196†	No. 3 Woodruff Key	.05
9-114†	Feed Screw Gear Stud Wash.	.25	9-197†	No. 9 Woodruff Key	.05
9-115	Combination Wrench	.30	9-198†	3/16x3/4 Groove Pin	.05
9-116†	Spindle Thrust Washer Pin	.10	9-199†	3/16x1 Groove Pin	.05
9-117	Clutch Shift Collar	1.25	9-200†	1/4x7/8 Groove Pin	.05
9-118†	Clutch Shift Collar Pin	.15	9-201†	No. 2x1/4 Parker Kalon Dr. Screw	.05
9-119	Clutch Jaw Collar	.60	9-202†	No. 6x3/4 Parker Kalon Dr. Screw Special	.05
9-120	Clutch Spacer	.10	9-203†	1/8x1 Cotter Pin	.05
9-121	Motor Base Brace	.15	9-204	No. 324 Oiler Style "R"	.15
9-122	Motor Base Hinge Pin	.15	9-205†	No. 502 Oiler Style "C"	.15
9-123	Ctr. Shaft Hinge Pin	.15	9-206	No. 7003 Grease Cap Style "GA"	.15
9-124†	Set Screw Plug	.10	9-207	Toggle Switch	.50
9-125	V-Belt (Comp. Drive)	1.55	9-208	Cord Ass. No. 18-2 Cord	.75
9-126	V-Belt (Cone Pulley)	1.45	9-210†	3/16 Steel Ball	.05
9-127	V-Belt (Motor Drive)	1.75	9-211†	6-32x3/8 Rd. Hd. Machine Screw	.05
9-128†	Shims	.15	9-212†	Rubber Bushing	.05
9-131	Switch Box	.50	9-213†	10-24 Hex. Nut	.05
9-132S	Switch Box Cover Plate	.25	9-214†	Conn. Cord No. 18-2 Cord	.45
9-133	Change Guard Cover Stud	.10	9-215†	1/4"x1/4" RH Mach. Screw	.05
9-134	Change Gear Guard Cover Nut	.10	9-216†	1/4" Stand. Washer	.05
9-136	Tool Post Anchor and Stud	.50	9-217†	No. 15x1/4 Escutcheon Pin	.05
9-138	Center Sleeve	1.00	9-218†	Size 10 Mach. Screw Wash.	.05
9-161†	8-32x1/8 Headless Set Screw	.10	9-219†	1/4x1-1/2 Hd. Lag Screw	.05
9-162†	10-24x1/4 R.H. Mach. Screw	.05	9-224†	5/16-18x1/2 Cap Screw	.05
9-163†	1/4-20x1/4 Headless Set Screw	.10			
9-164†	1/4-20x3/8 Headless Set Screw	.05	9-300†	Compound Rest Assembly	15.50
9-165†	1/4-20x5/8 Headless Set Screw	.05	9-301	Compound Rest Swivel	4.75
9-166†	1/4-20x1/2 Allen Set Screw, ea.	.10	9-302	Compound Rest Swivel (Upper)	3.75
9-167†	1/4-28x1/2 SAE Headless Set Screw	.10	9-303	Compound Rest Tool Post Slide	3.75
9-168†	1/4-20x3/8 Fil. Head Machine Screw, ea.	.05	9-304	Compound Rest Tool Post Gib	.20
9-169†	1/4-20x1/2 Fil. Head Machine Screw, ea.	.05	9-305	Compound Rest Feed Screw	.90
9-170†	1/4-20x3/4 Fil. Head Machine Screw, ea.	.05	9-306	Compound Rest Feed Screw Nut	.75
9-171†	1/4-20x3/8 Rd. Hd. Machine Screw	.05	9-307	Compound Rest Feed Thrust Plate	.80
9-172†	1/4-20x1/2 Hex. Hd. Cap Screw	.10	9-308	Compound Rest Feed Dial	1.45
9-173†	5/16-18x2 Headless Set	.10	9-309†	Compound Rest Swivel Clamp Bolt	.20
9-174†	5/16-18x3 Headless Set	.10	9-56	Cross Feed Gib	.20
9-176†	5/16-18x3/4 Hex. Hd. Cap Screw	.05	9-171†	1/4-20x3/8 Rd. Hd. Mach. Screw	.05
9-177	Carriage Lock Screw	.05	9-162†	10-24x1/4 Rd. Hd. Mach. Screw	.05
9-178†	5/16-18x1-1/4 Mach. Bolt	.05	9-220†	10-32x1/2 Headless Set Screw	.10
9-179	Threading Dial Screw	.10	9-167†	1/4-28x1/2	.05
9-180†	3/8-16x5/8 Sq. Hd. Set Screw	.15	9-221†	1/4-20x1/2 Rd. Hd. Mach. Screw	.05
9-181†	3/8-16x1-3/4 Sq. Hd. Set Screw	.05	9-196†	No. 3 Woodruff Key	.05
9-182†	3/8-16x2 Sq. Hd. Set Screw	.20	9-222†	5/16-18 Hex. Check Nut	.05
9-183†	3/8-16x2-1/4 Hex. Hd. Cap Screw	.05	9-215†	1/4-20x1/4 Rd. Hd. Mach. Screw	.05
9-184†	3/8-16x2-3/4 Hex. Hd. Cap Screw	.05	9-218†	No. 10 Mach. Screw Washer	.05
9-185†	1/2-13x1-1/4 Hex. Hd. Cap Screw	.05	9-310	Compound Rest Wrench	.25

† Not illustrated.

Order all REPAIR PARTS direct from Sears, Roebuck and Co.,  
1851 No. Pitcher St., Kalamazoo, Mich.

## Decimal Equivalents of Parts of an Inch

	$\frac{1}{64}$	.015625		$\frac{11}{32}$	.34375		$\frac{43}{64}$	.671875
	$\frac{1}{32}$	.03125		$\frac{23}{64}$	.359375		$\frac{1}{16}$	.6875
	$\frac{3}{64}$	.946875		$\frac{3}{8}$	.375		$\frac{45}{64}$	.703125
$\frac{1}{16}$		.0625		$\frac{25}{64}$	.390625		$\frac{33}{64}$	.71875
	$\frac{5}{64}$	.078125		$\frac{13}{32}$	.40625		$\frac{47}{64}$	.734375
	$\frac{3}{32}$	.09375		$\frac{27}{64}$	.421875		$\frac{3}{4}$	.75
	$\frac{7}{64}$	.109375		$\frac{1}{16}$	.4375		$\frac{49}{64}$	.765625
$\frac{1}{8}$		.125		$\frac{29}{64}$	.453125		$\frac{35}{64}$	.78125
	$\frac{9}{64}$	.140625		$\frac{15}{32}$	.46875		$\frac{51}{64}$	.796875
	$\frac{5}{32}$	.15625		$\frac{31}{64}$	.484375		$\frac{1}{16}$	.8125
	$\frac{11}{64}$	.171875		$\frac{1}{2}$	.5		$\frac{53}{64}$	.828125
$\frac{3}{16}$		.1875		$\frac{33}{64}$	.515625		$\frac{37}{64}$	.84375
	$\frac{13}{64}$	.203125		$\frac{17}{32}$	.53125		$\frac{55}{64}$	.859375
	$\frac{3}{32}$	.21875		$\frac{35}{64}$	.546875		$\frac{7}{8}$	.875
	$\frac{15}{64}$	.234375		$\frac{9}{16}$	.5625		$\frac{57}{64}$	.890625
$\frac{1}{4}$		.25		$\frac{37}{64}$	.578125		$\frac{39}{64}$	.90625
	$\frac{17}{64}$	.265625		$\frac{19}{32}$	.59375		$\frac{59}{64}$	.921875
	$\frac{9}{32}$	.28125		$\frac{39}{64}$	.609375		$\frac{15}{16}$	.9375
	$\frac{19}{64}$	.296875		$\frac{5}{8}$	.625		$\frac{61}{64}$	.953125
$\frac{5}{16}$		.3125		$\frac{41}{64}$	.640625		$\frac{31}{32}$	.96875
	$\frac{21}{64}$	.328125		$\frac{21}{32}$	.65625		$\frac{63}{64}$	.984375
							1	1.

## DON'TS FOR MACHINISTS

*from "Machinery"*

- Don't abuse but use tools.
- Don't gamble with danger; too many have tried it and lost.
- Don't use one mandrel to drive another one out of a piece of work.
- Don't rap the chips out of your file on the lathe shears.
- Don't change chucks or jaws without cleaning out the spindle nose.
- Don't use a file without a handle in a lathe.
- Don't try to cut threads on steel or wrought iron dry; use lard oil or a cutting compound.
- Don't leave a chuck wrench in a chuck; always remove it.
- Don't try to straighten a shaft on lathe centers, and expect that the centers will run true afterward.
- Don't blow filings or chips in among the running parts of a machine.
- Don't set the cutting points of a lathe or planer tool any farther out from the tool post than is absolutely necessary.
- Don't try to knurl a piece without oiling it.
- Don't forget that the closer you can get your tool-rest to the work, the better it is.
- Don't oil or clean a machine while it is in motion.