

New

**walker-
Turner**

COMPANY, INC.
PLAINFIELD, N.J.

MACHINE TOOLS

FOR WOOD AND METAL

1940

CATALOG C-O

Engineered FOR INDUSTRY

In manufacturing plants . . . large and small alike . . . new economies obtained with modern, low cost Walker-Turner machines are fast making them an indispensable part of today's plant equipment. Walker-Turner machines are enabling thousands of alert manufacturers to meet exacting production schedules, to keep machine investment down and to lower power loads and maintenance costs.

Walker-Turner machine tools can do this because they are correctly engineered. In the Walker-Turner organization is a staff of highly trained specialists who knowing industry's problems are giving full time to solving them. That they have been successful in contributing in a substantial way is attested by the fact that thousands of industrial plants have adopted Walker-Turner machines and are constantly adding to them.

If you want to know, in a definite way, what they are doing for others and can do for you, call in your local distributor. He'll give you the facts.



*Plus 200% on all
prices for Western
Trade F.O.B. Region.*

INDEX

BAND SAWS	10 & 51	GRINDERS, BENCH	43	LATHES	32 & 49	SURFACERS	22
BENCH SAWS	15 & 48	GRINDERS, MOTOR	41	MOTORS	36	TILTING ARBOR SAWS	16
DRILL PRESSES	3 & 50	JIG SAWS	24 & 51	RADIAL SAW	26	TRANSMISSION EQUIP- MENT	42
FLEXIBLE SHAFTS	44	JOINTERS	20 & 50	SHAPERS	28		

Walker-Turner machines are sold only through authorized distributors.

All prices F.O.B. Plainfield, N. J., and subject to change without notice. Slightly higher at distant points for transportation. Also subject to local, state or federal sales tax wherever such taxes are in force. The Walker-Turner Company reserves the right to make changes in design, or to make additions to or improvements in its products without imposing any obligation upon itself to install them on its products previously manufactured.

15" BENCH MODEL DRILL PRESSES

- New one-piece table with larger working area
- Straddle-mounted pulley design gives extra rigidity
- 6 spline spindle (pioneered by W-T) minimizes vibration
- 4 precision ball bearings correctly located
- One-piece head casting closely fitted to column
- Balanced pulleys nickelized for long wear (an exclusive feature)
- Jacobs 0-1/2" key chuck regular equipment
- Guaranteed accuracy greater than that of machines selling at many times the price.

Their consistent, smooth running accuracy and freedom from repairs have won for Walker-Turner Drill Presses an enviable record of performance in thousands of industrial plants. Experienced shop men find these modern, efficient machines far ahead of the field . . . in design, in accuracy and in value. A study of the cutaway section of the head, page 5, will show you why Walker-Turner Drill Presses perform better and last longer.

SPECIFICATIONS

CAPACITY: chuck to table 12" . . . chuck to base 17 1/2" . . . center of chuck to column 7 1/2", drills to center of 15" circle.
CHUCK: Jacobs key type, 0-1/2" capacity.
TABLE: new one piece type with larger working area 10" x 12 1/2". Tilting table optional at no extra cost.
BEARINGS: 4 precision ball bearings mounted one above and one below pulley; other two in rack.
BASE: heavy casting with machined surface 10" x 9".
SPINDLE: 6 spline, 3/8" diameter tapered at end for Jacobs chuck and collets.
SPINDLE TRAVEL: 4", adjustable spring return.
COLUMN: ground seamless steel tubing, 2 3/4" diameter.
RACK: machined from solid bar steel, 1 1/8" diameter. Teeth milled in rack to match pinion.
PILOT WHEEL FEED: with bakelite knobs, calibrated depth stop.
HEAD: close grained gray iron. Parts machined to close tolerances.
ADAPTER: number #1 Morse Taper adapter available to fit tapered spindle.
STANDARD SPEEDS: with 1740 R.P.M. motor, 600, 1250, 2440, 5000.
SLO SPEED MODEL SPEEDS: 480, 940, 1300, 2900 R.P.M.
OVERALL MEASUREMENTS: height 39 1/2", width 10", depth 25".
SHIPPING WEIGHT: 125 lbs. without motor.

WORTHWHILE FEATURES

Husky head construction, calibrated depth stop, positive locking device and Jacobs chuck are typical of the refinements used throughout. The column collar which permits swinging the head, conveniently located motor switch and belt guard are shown in these photos.

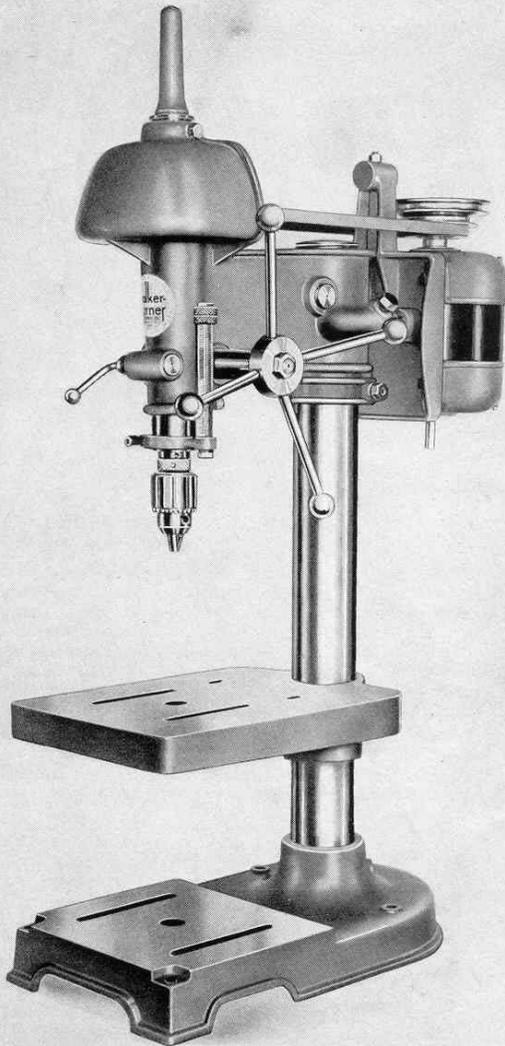
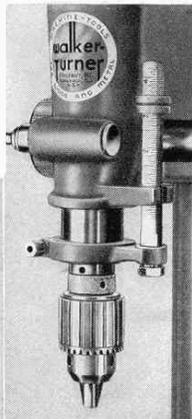
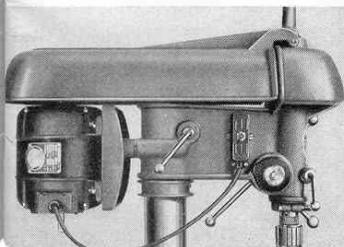

U.S. Pat. No. 2,072,646 • Design Pat. No. 91,094

- D950** As shown above, standard speeds less motor **\$57.95**
- D951** Same as D950 excepting that it is slower speed; see specifications. . . . **59.45**
- 9D111** New motor bracket for attaching slo-speed attachment to old models. . . . **2.55**

Motor recommended 1/3 H.P., 1740 R.P.M. Available with tilting table on special order.

PRODUCTION MODELS

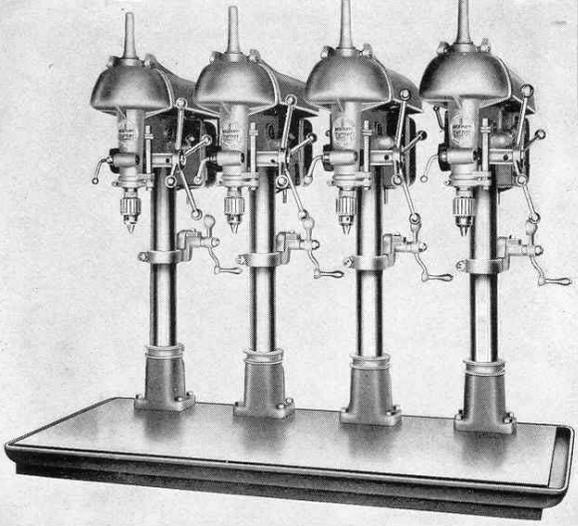

- Maximum distance chuck to table, 18 1/2"
- Maximum distance center of chuck to column, 7 1/2"
- Center to center of chucks 11"
- Machined cast-iron table 17" by 45" on 4 spindle models, 17" by 23" on 2 spindle models
- Head raising and lowering mechanism
- Available with or without heavy gauge steel stands
- Heads can be swung to right or left independently of each other
- Overall size, 4 spindle model without stand: height 42", width 50", depth 29"
- Overall size, 2 spindle model without stand: height 42", width 27 1/2", depth 29"
- Shipping weights, less stand, motors and belt guards:
4 spindle model, 620 lbs., 2 spindle model, 360 lbs.

2 AND 4 SPINDLE DRILL PRESSES

These new Walker-Turner multiple spindle models are designed to cover the widest possible range of service at new, low levels of investment and operating costs. Inspection will show you that the vital parts of these drill presses are machined to closer tolerances than similar parts found in other drill presses selling at much higher prices. Their sturdy construction permits many other operations beside drilling to be done economically and accurately.

Each head is provided with a raising and lowering device and a column stop collar. All spindles have six splines and turn on four precision ball bearings. Pulleys are balanced and nickelized for long wear.

D904	4 spindle drill press, as shown above less motors, and belt guards.....	\$380.65
94	Steel stand for above.....	36.25
D902	2 spindle drill press, as shown at right, less motors, belt guards and stand.....	181.25
92	Steel stand for above.....	29.00
9D55	Belt guard.....	7.20
(Motors recommended 1/2 H.P., 1740 R.P.M.)		

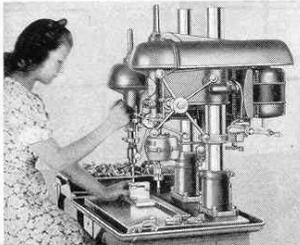
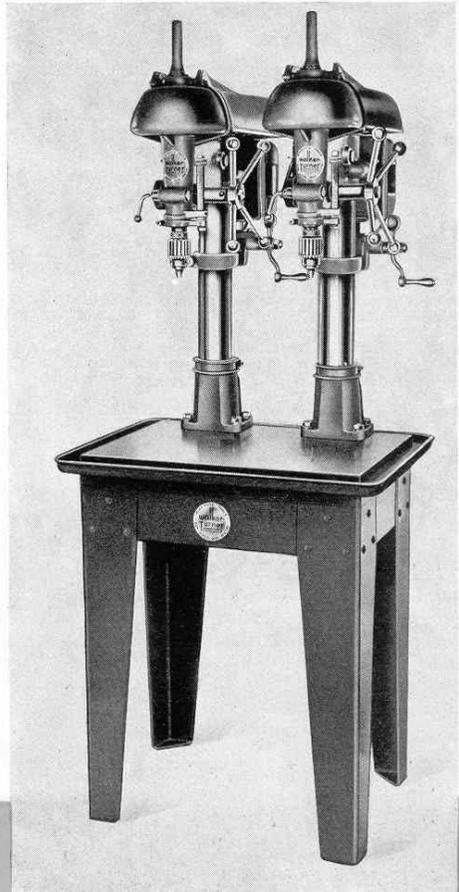

In large and small shops alike, the new economies obtained with modern, low cost Walker-Turner drill presses are rapidly making them an indispensable part of today's plant equipment.

Many of these head assemblies are now being used for spinning rivets, light routing and milling, grinding with small wheels and similar operations.

ACCURATE-STURDY

DRILL PRESS HEADS

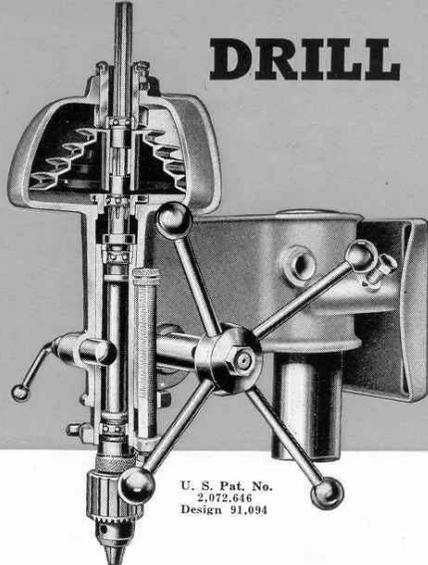

U. S. Pat. No.
2,072,616
Design 91,094

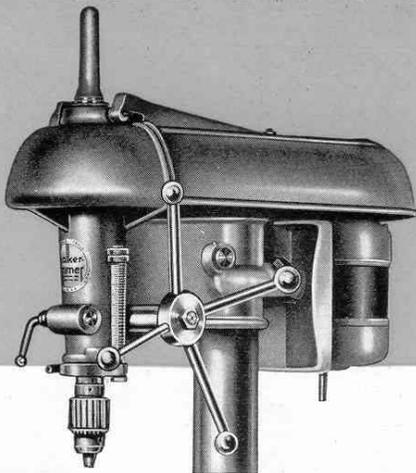

Many enterprising plant men have accomplished almost unbelievable economies by adapting standard Walker-Turner drill heads to special set-ups. A few such set-ups are shown below. These heads with motors are self-contained units and, because of their design, can be operated in any position, horizontal, vertical or inverted. These heads are available separately with a wide selection of attachments.

9D13X	Head assembly, as shown above, less motor and belt guard, shpg. wgt. approx. 65 lbs.	\$46.05
9D11	31"x2 3/4" ground steel column	5.75
9D55	Belt guard	7.20
9D17	Idler assembly (see photos below)	5.10
VB92	92" belt for idler drive	2.90

(for other attachments see next page)

SPECIAL SET-UPS PAY BIG DIVIDENDS

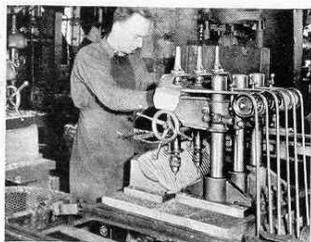

Savings up to thousands of dollars annually are being made by concerns using Walker-Turner drill heads in special set-ups to side step expensive tooling or machinery costs.

These photos show typical money saving installations.

The photo at right shows a portable combination unit made up of four standard Walker-Turner drill press heads. This set-up developed by one manufacturer has successfully solved his problem. A hydraulic feed mechanism adds to the efficiency of this machine.

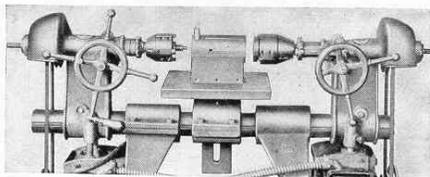

With the set-up above one manufacturer has faced over 280,000 castings without replacement or repair of any part, saving 75% in labor.

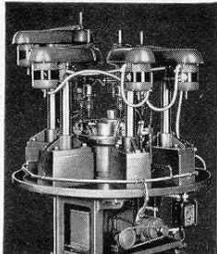

In the set-up below auto radiator grilles are being drilled on a double bank of W-T drill heads. This set-up cost only a fraction of what a conventional set-up would ordinarily cost and has saved its owner thousands of dollars . . . also, it has provided greater flexibility of production.

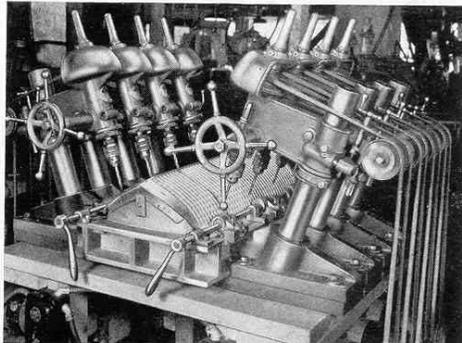

W-T MACHINES SAVE YOU MONEY

PRACTICAL ATTACHMENTS

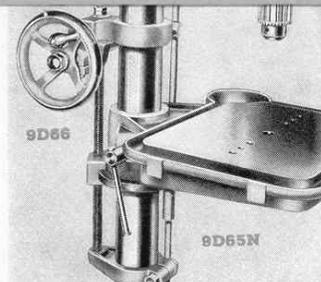

TABLE RAISING MECHANISM

A production table 12" by 10" is shown with the new table raising and lowering mechanism. They fit any drill press with 2 3/4 in. diameter column and are very easily attached.

9D65N Production table.....**\$8.35**
9D66 Table raising mechanism (with hand crank instead of wheel shown).....**10.90**

HEAD RAISING MECHANISM

Fits all "900" series drill presses with 2 3/4" columns. Functions equally well with the head and column in any position. It is positive in action yet easy to operate. The raising and lowering mechanism is movable around the column with the head assembly. Has hand crank instead of wheel shown.

9D75 Head raising mechanism (for bench model).....**\$9.45**
9D76 Head raising mechanism (for floor model, with foot feed)..... **9.45**

NEW MORSE TAPER ADAPTER

With this adapter attached to any series "900" drill press spindle in place of the chuck, number 1 Morse Taper shank drills may be used. The convenience of being able to use M.T. drills or the Jacob chuck interchangeably adds another feature to this superb drill press.

9MT1 Morse Taper adapter including drift pin as shown.....**\$4.35**

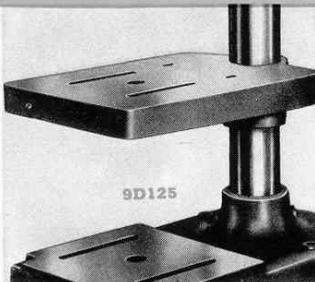

ONE-PIECE TABLE

Supplied as regular equipment on standard bench and floor models is a new sturdy one-piece table with 12 1/2" x 10" machined working surface providing greater usable table area. The table is locked in position on the column by a conveniently located clamp lever.

9D125 One-piece Table (fits 2 3/4" diam. columns).....**\$5.10**

Walker-Turner Drill Presses are designed to perform several different operations . . . not only adequately . . . but efficiently. With the proper attachments you can do mortising, shaping, routing, dovetailing and similar woodworking operations. They are also used for tapping, rivet-spinning, and light milling.

The attachments shown on this page and on page 8 definitely increase the versatility and utility of Walker-Turner drill presses . . . enabling the owner to get more service without increasing the machine investment.

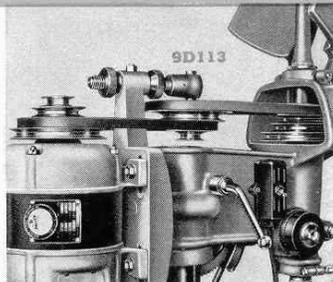

SLO-SPEED ATTACHMENT

This new drive provides a wide range of usable speeds from a low of 165 R.P.M. to a high of well over 5000 R.P.M. The pulley assembly attaches to the motor base bracket now standard equipment on "900" drill presses. Adjustable belt tension. 9D111 not included. The pulley turns on dust-sealed, precision ball bearings. This attachment may be fitted to the older "900" models if old motor plate is replaced by new type listed below. The photo above shows how the attachment is installed.

9D113 Slo-speed attachment, including ball bearing mounted pulley and 2 24" V belts.....**\$9.10**

9D111 Motor plate for 9D113 (for older models)..... **2.55**

EXTENSION ARM

The extension arm increases the distance between the main column and the drill to 24". Intended for light drilling, it is useful for drilling or tapping holes in large sheets, plates and other wood or metal panels. For use on all bench model drill presses with 2 3/4" columns. Swings on accurately fitted bearings and is movable up and down the column.

9D6 Extension Arm complete.....**\$25.40**

HIGH SPEED TAPPING ATTACHMENTS

No.	General Capacity	Capacity In			Steel	Maximum Speed	Weight	Price
		Brass	Aluminum	Cast Iron				
1B	No. 6 to 1/4" taps	3/8"	3/8"	1 3/16"	1/4"	1800 R.P.M.	5 1/2 lbs.	\$64.90
2B	No. 10 to 3/8" taps	1/2"	1/2"	1 1/16"	3/8"	1200 R.P.M.	8 1/2 lbs.	\$82.65

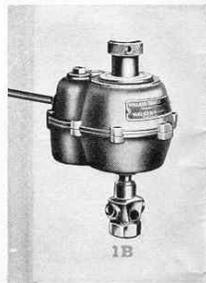
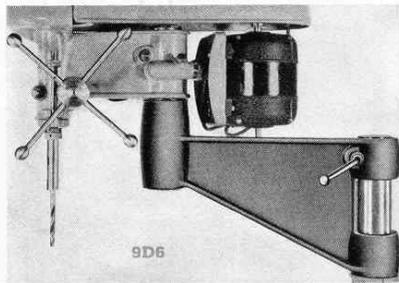
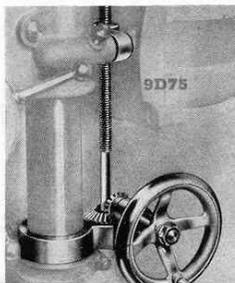
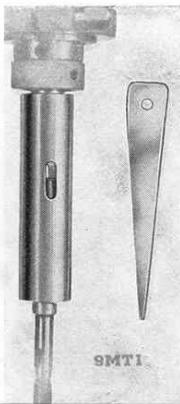

FOR WALKER-TURNER DRILL PRESSES

FLOOR MODELS

- Distance chuck to base 46"
- Round base affords greater portability
- 6 spline spindle, 4" travel
- Balanced, nickelized pulleys for long wear
- Foot-feed available at slight extra cost

Floor models have the same head assemblies as the bench models. Columns are 60" in length. Single, positive action foot-feed is easily attached to all floor models. Head and table may be swung to various positions around column.

SPECIFICATIONS

HEIGHT: Overall 69".

BASE: Is 22" in diameter, has machined working surface.

DISTANCE: Maximum chuck to base, 46".

SPEEDS: 600, 1250, 2440, 5000 R.P.M. with 1740 R.P.M. motor.

SHIPPING WEIGHT: Without motor, 185 lbs.

Other specifications same as D950 model page 3.

D935 As shown in photo below . . . \$68.90

D937 Same as D935 but Slo-speed. 70.35

9D80N Foot-feed attachment, fits floor models with 2 3/4" columns . . . 21.75

D936 With belt guard, production table, Standard speed. 79.40

D938 Same as D936 but Slo-speed. 80.85

FD961 As shown at right, less motor, 112.00
Standard or Slo-speed optional

Motor recommended, 1/3 H.P. 1740 R.P.M.

CORRECT BEARING SUPPORT

The straddle-mounted construction of the W.T. head with ball-bearings directly above and below the pulley gives proper support to the pulley. The spindle "floats" freely through the pulley with no belt strain transmitted to the spindle.

Model D935, below, is supplied with slotted table, 10" x 9". Belt guard, foot-feed attachment and other accessories are available at extra cost.

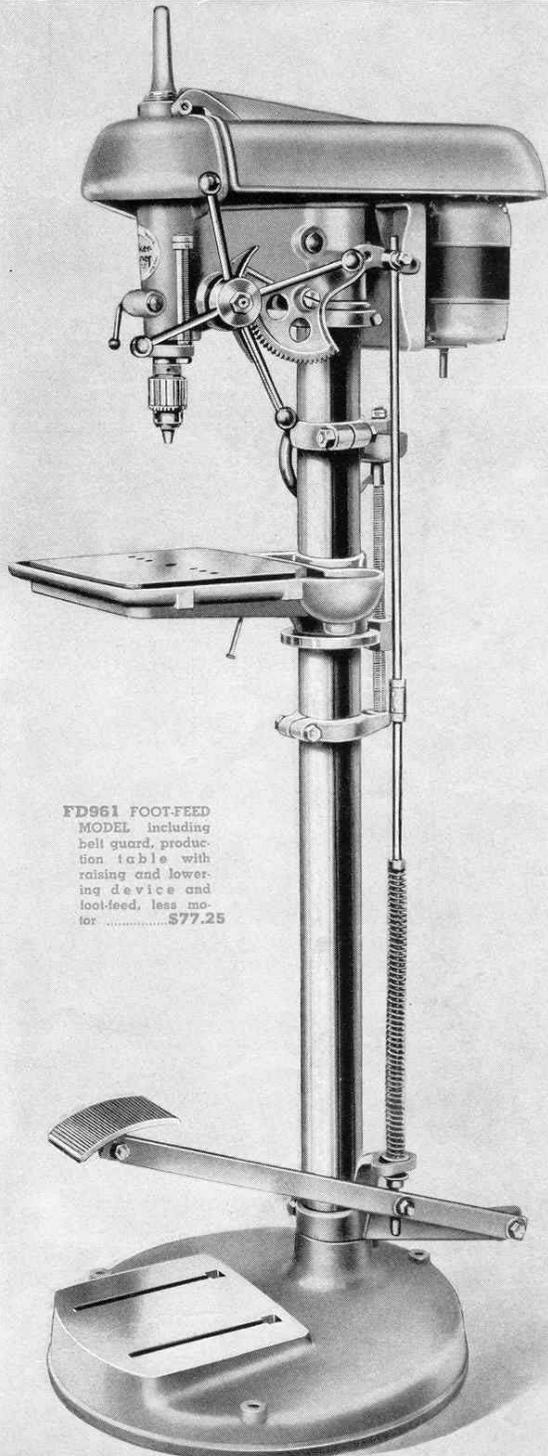
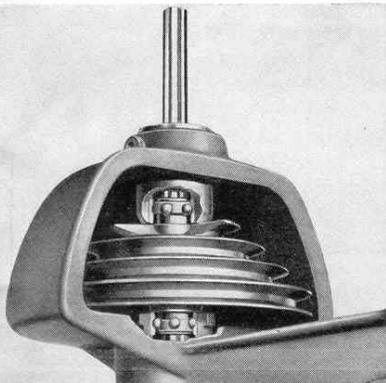

FD961 FOOT-FEED MODEL including belt guard, production table with raising and lowering device and foot-feed, less motor \$77.25

DRILL PRESS ACCESSORIES

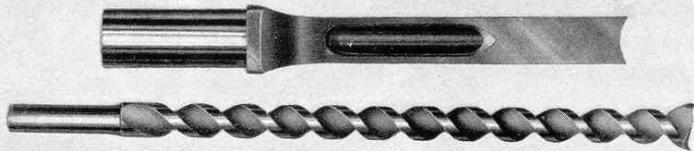
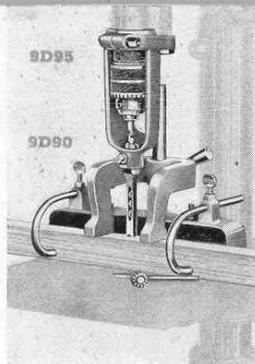

MORTISING CHISELS AND BITS

STANDARD (for the home shop)

These chisels are made from high carbon tool steel, carefully heat-treated and hardened. Used on "700" and "900" Drill Presses.

HC25 1/4" Hollow Chisel.....	\$2.40
HC38 3/8" Hollow Chisel.....	2.40
HC50 1/2" Hollow Chisel.....	2.40
HC25A 1/4" Bit	2.20
HC38A 3/8" Bit	2.20
HC50A 1/2" Bit	2.20

SPECIAL (for commercial use)

These chisels will hold their keen edges longer and give extra hours of continuous, uninterrupted service. The standard bits listed at left are used with these chisels.

HCS4 1/4" Special Chisel.....	\$4.40
HCS5 3/8" Special Chisel.....	4.40
HCS6 3/8" Special Chisel.....	4.40
HCS8 1/2" Special Chisel.....	6.60
HCS5A 3/8" Bit (for HCS5).....	1.90

GRINDING SHAPE



Ideal for sharpening hollow mortising chisels.

D Aluminous oxide stone.....\$1.55

MORTISING ATTACHMENT

This attachment in place of the stop collar holds hollow chisels permitting mortises of 1/4", 3/8", 1/2" or 5/8" to be made in any wood.

9D95 For Series 900 Models.....	\$2.75
7D85 For Series 700 Models.....	2.75

HOLD-DOWN AND GUIDE

Sturdy and readily adjustable this hold-down and guide may be locked in position just above the piece to be mortised to prevent it from being lifted on the upward movement of the chisel.

9D90 Hold-down and Guide (for "700" & "900" drill presses) (illustrated)....	\$4.70
---	---------------

CARVING AND SHAPING ATTACHMENTS

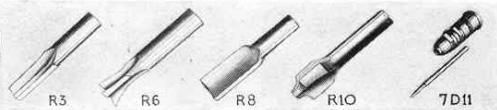

ROUTING • CARVING • DOVETAILED

Attached to drill press with collet chuck (7D11). All bits have 1/16" shanks.

R1 1/8" Router bit.....	\$1.00
R2 1/4" Router bit.....	1.00
R3 3/8" Router bit.....	1.00
R4 1/4" Dovetail bit.....	1.00
R5 3/8" Dovetail bit.....	1.00

R6 1/2" Dovetail bit.....	\$1.00
R8 5/8" Router bit.....	1.60
R9 1" Router bit.....	1.60
R10 1/2" Carving bit.....	1.60
R12 3/4" Carving bit.....	1.60
7D11 Collet Chuck	1.55
DP118 Collet Chuck	1.10



CARVING CUTTERS

These cutters are made of highest quality carbon steel and are ideal for fine routing and carving.

CR8 Saw95	CR12 Pointed95
CR9 Round95	CR13 Cylindrical95
CR10 Flame95	CR20 Set of 6 Burrs (1/8" shanks)	5.60
CR11 Inverted Cone95		

DRILL SELECTOR AND EIGHT DRILLS



Eight high quality carbon steel drills—in a unique metal container—at a lower price than you would ordinarily pay for drills alone. Sizes 1/16", 1/8", 3/16", 1/4", 5/16", 3/8", 7/16", 1/2".

TD117 Drill Selector with 8 drills.....\$2.40

HOLD-DOWN SPRINGS

These springs used with the guard and guides increase the safety and accuracy of shaping.

558 Set of Spring	
Hold-downs	\$2.40

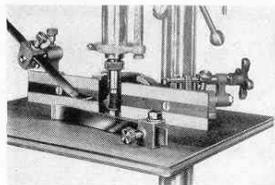

TABLE FOR SHAPING

This large five-ply wood table, fitted with threaded metal inserts for holding the shaping guard and guides greatly increases the convenience of shaping on the drill press. It is attached to the top of the regular drill press table. Fits both Series 700 and 900 drill presses. Size 18" x 14 3/8".

557 Shaping Guard and Guides.....	\$4.80
9D3 Wood Extension Table for Shaping	\$4.80

GUARDS & GUIDES

For accurate work this attachment is almost indispensable. It restricts the depth of cut to a prescribed point. The front guide has a micromatic setting for adjustment. (Used only with 9D3.)

557 Shaping Guard and Guides.....	\$4.80
--	---------------

DRILL PRESS ADAPTERS



DP120 5/16" ADAPTER for small cutters (SS5-SS12 shown on page 31)	\$.50
--	---------------

9D5 1/2" ADAPTER for "700" and "900" models	1.55
--	-------------



INCREASE YOUR MACHINES' UTILITY

13" DRILL PRESS

- Jacobs key chuck supplied as regular equipment
- 6 spline spindle, full-floating type, $\frac{5}{8}$ " diameter, tapered at lower end for Jacobs chuck
- 4 precision ball bearings, one mounted directly above pulley, other directly below, other two in rack or quill
- Head and table both movable up and down column
- Adjustable depth stop with indicator simplifies drilling a series of holes to identical depth
- Superior method of clamping quill, table, collar and head in position prevents any possibility of the clamping device marring the finely ground surfaces of column or quill
- New one-piece table with larger working area or old tilting table optional
- Special motor base for multi-speed attachment included in regular equipment

SPECIFICATIONS

CHUCK: Jacobs key type, $\frac{1}{8}$ " to $\frac{1}{2}$ " capacity.

BEARINGS: 4 precision ball bearings mounted one above and one below the pulley, other two in quill.

CAPACITY: Chuck to table $11\frac{1}{2}$ ".
Chuck to base 17".

TABLE: New one piece type $9" \times 10\frac{1}{2}"$, machined smooth, tilting table optional.

BASE: Heavy casting with machined surface $9" \times 8"$.

COLUMN: Seamless steel tubing machined to close tolerances, 2" diameter.

SPINDLE TRAVEL: $3\frac{1}{2}"$, calibrated depth stop.

SPINDLE: 6 spline, $\frac{5}{8}"$ diameter tapered at end for Jacobs chuck.

HEAD: Close-grained gray iron. Parts machined to close tolerances. Spindle cap gives extra protection to operator.

SPEEDS: 600, 1250, 2440, 5000 R.P.M.

HEIGHT: Overall 38".

SHIPPING WEIGHT: Without motor, 95 lbs.

SLO-SPEED ATTACHMENT

This new drive provides a wide range of usable speeds from a low of 165 R.P.M. to a high of well over 5000 R.P.M. The pulley assembly attaches to the motor base bracket now standard equipment on "700" drill presses. Belt tension is adjustable. Photo below shows how attachment is installed.

7D113 Slo-speed attachment, including ball bearing mounted pulley and 24" and 26" V belts. **\$9.10**

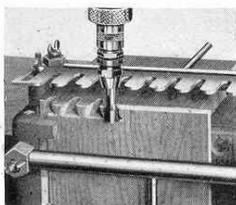

DOVETAIL JIG

This jig used on the drill press makes $\frac{1}{2}"$ dovetail joints easily and accurately. Because both male and female members of the joint are cut simultaneously a perfect fit is assured. Available for $\frac{1}{2}"$ only.

The 7D11 collet chuck is used with this jig for dovetailing.

7D10 Dovetail jig complete including R6 $\frac{1}{2}"$ bit **\$5.75**

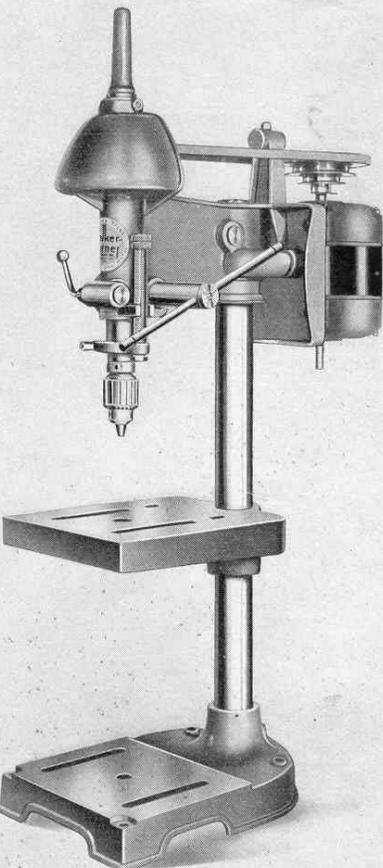

U.S. Pat. No. 2,072,646 • Design Pat. No. 91,094

- D715** Drill Press, as shown less motor; includes V-belt and motor pulley. Tilting table optional **\$43.45**
- 9D17** Idler Assembly **5.10**
- VB86** 86" Belt for Idler Drive **1.90**
- 9D111** New Motor Bracket (for attaching slow-speed attachment to older models) **2.55**
- 7D24** Column collar **.90**
Motor recommended, $\frac{1}{2}$ H.P., 1740 R.P.M.

SANDING

With the DS type sanding drums, page 23, curved edges of wood, metal or plastic pieces are sanded easily, quickly and smoothly. Because the spindle is movable up and down the operator can easily get the effect of an oscillating drum sander with this set-up.

With a guide clamped to the table straight sanding can be done on small strips. Available in three diameters, $1\frac{1}{2}"$, $2\frac{3}{16}"$ and 3".

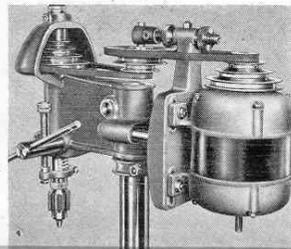

ANOTHER WALKER - TURNER VALUE!

16 and 14 INCH METAL

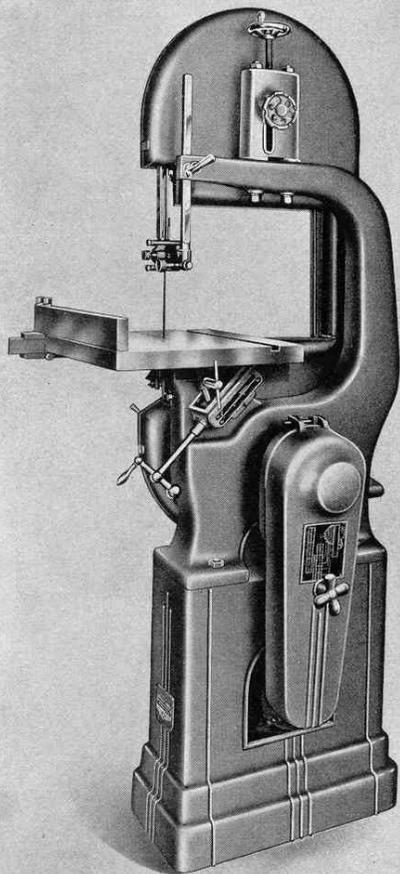

- All wheel bearings are heavy duty precision ball bearings
- Tables are heavily ribbed and carefully machined, tilt to 45° and have mitre gauge grooves
- Wheels are carefully balanced and rubber faced
- Blade guides have ball bearing thrust wheels and adjustable steel-faced guide pins designed especially for metal cutting
- Blade tensioning devices have spring cushions to absorb shocks
- Guard construction assures complete protection to operator
- Back gear unit provides wide range of slow speeds
- Heavy cast-iron, one piece frames have extra strength and rigidity

Every tool room, experimental department, general machine shop and metal-working plant has an opportunity to save money with these new back-geared band saws. They cut sheets, rods and tubes of steel, iron, aluminum, brass, alloys and compositions quickly, accurately and economically. Molded plastics such as bakelite and catalin are also cut or trimmed efficiently on these metal cutting band saws.

In many shops these machines will pay for themselves on the first job. Their low initial cost and high operating efficiency combine to make them indispensable tools . . . money-makers from the start.

The geared speed reducer is a precision unit designed by engineers who know what is required of such a unit. A glance at the photos on the opposite page will show you that it is correctly and substantially designed for long-run, trouble-free service on steady production work. A feature that adds still greater value is the fact that the metal cutting machine may be speeded up for woodworking. By simply throwing the lever which disengages the gear train and engaging a pin it is immediately converted into a direct-drive machine with correct speeds for woodworking.

U. S. Pat. No. 1,996,825

MBN1105 16" metal cutting band saw, as shown, less motor, rip fence and base. Includes 1/2" blade, metal cutting guides, belt guard, belt and motor pulley.....	\$200.85
11BN4 Cast-iron base, 140 lbs.....	25.40
KAB55 1/2 H.P., 1740 R.P.M. motor, 110 volts, AC, 60 cycles.....	35.55
GIB5 1/2 H.P., 716 R.P.M. geared motor, single phase, 110-220 volts, AC, 60 cycles.....	72.50
GIB7 3/4 H.P., 716 R.P.M., 3 phase, 220 volts, AC, 60 cycles motor.....	79.75

Because of its extra length the 716 R.P.M. motor cannot be mounted in the base. To mount it at rear 9BN140 must be used.

9BN140 Plate for attaching 716 R.P.M. motor....	3.65
--	-------------

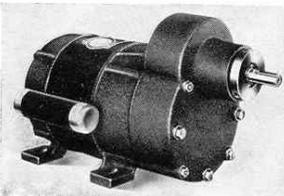

SLO-SPEED MOTOR

A new 716 R.P.M. back geared motor provides the extremely slow speeds necessary in cutting certain types of steel. Used on these metal cutting machines many speeds are available.

FRONT VIEW (RIGHT)

One of the extra advantages of these metal cutting band saws is that they can quickly be converted into direct-drive higher speed machines for sawing wood, plastics and non-ferrous metals. Both models are available without bases (with transmission to rear of machine instead of down to base).

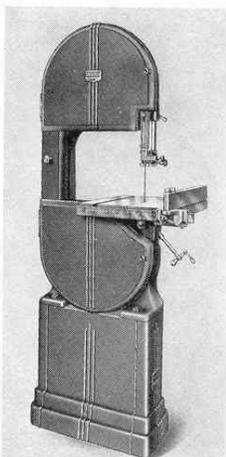

YOU CAN MAKE REAL SAVINGS

CUTTING BAND SAWS

SPECIFICATIONS

(16" and 14" Models)

WHEELS: Gray iron carefully machined and balanced, rubber faced.
BALL BEARINGS: Large dust-sealed, precision in both wheels.
GUIDES: Are both ball-bearing with special steel insert blocks for metal cutting.
WHEEL GUARDS: Are cast-iron hinged for convenience . . . telescoping guards at area of operation.
ADJUSTING MECHANISM: Blade and upper wheel mounted on two heavy ground steel rods . . . Cushion springs absorb blade shocks.
MOTOR BRACKET: At rear of frame supplied with 16" model. For 14" model available as an extra.
BLADE SPEEDS: Standard motor, 16" model, 200, 300, 400, 560, 2000, 3000, 4150, 5300 F.P.M. 14" model, 175, 260, 350, 490, 1750, 2625, 3630, 4630 F.P.M. Slow-speed motor, 16" model, 70, 106, 151, 208, 746, 1129, 1607, 2216 F.P.M. 14" model, 61, 93, 132, 182, 653, 1103, 1413, 1950 F.P.M.

	16" Model	14" Model
Capacity, blade to frame.....	16"	14"
Capacity, guide to table.....	12"	7"
Table size.....	18" x 17"	16" x 16"
Blade speeds, ft. per min., standard motor.....	200-5300	175-4630
Blade speeds, ft. per min., slow-speed motor.....	70-2216	61-1950
Height overall, without base.....	50½"	44"
Height overall, with base.....	71½"	65"
Width.....	30½"	25¾"
Distance front to back.....	22"	20"
Shipping weight, without base or motor.....	405 lbs.	285 lbs.
Shipping weight, with base, less motor.....	545 lbs.	425 lbs.

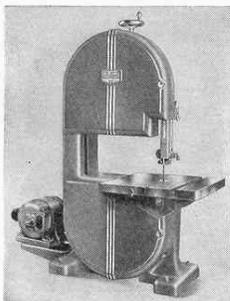
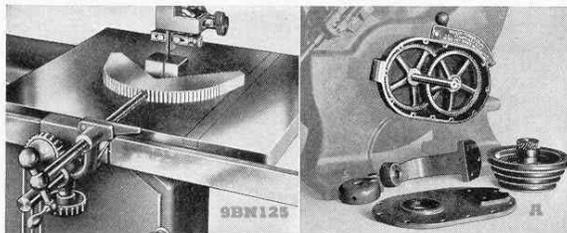

SCREW FEED

The screw feed with guiding segment, shown above left, greatly simplifies metal cutting. This attachment clamps to the table guide bar with the screw directly in line with the saw blade. The segment is not attached to table or screw. It holds square, hexagonal, triangular or round work in line without clamping while the screw advances it into the blade.

9BN125 including guide bar.....\$21.75

BACK-GEAR UNIT (A)

This photo shows how substantially this unit is built. It is designed for long-run, trouble-free service on steady production work. It provides eight speeds. The gear train can be disengaged and the machine operated on direct drive for higher speed operations.

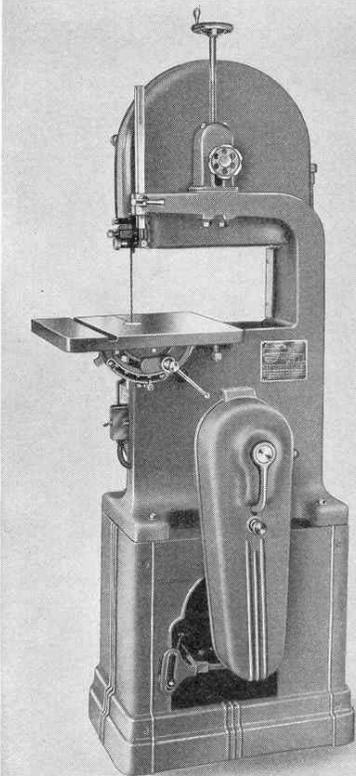

MBN935 14" metal cutting band saw, as shown above including belt, motor pulley and guard; less base and motor.....\$163.15

9BN5 Motor bracket for rear mounting (not needed with 11BN4)..... 3.65

11BN4 Base with motor bracket..... 25.40

EL5 Flexo lamp also fits 16" models..... 2.55

See page 10 for motors.

If 716 R.P.M. geared motor is used 9BN5 bracket and 9BN140 plate are required.

Catalog No.	BLADES FOR 16" BAND SAW			BLADES FOR 14" BAND SAW		
	11BN90	11BN91	11BN92	9BN55	9BN56	9BN57
Width	½"	½"	½"	½"	½"	½"
Length	114¾"	114¾"	114¾"	96¾"	96¾"	96¾"
No. of Teeth per in.	10	14	18	10	14	18
Price	\$3.45	\$3.45	\$3.45	\$2.50	\$2.50	\$2.50

Above blades for mild steel and non-ferrous metals. A chart of blades recommended for various materials upon request

WITH A WALKER-TURNER BAND SAW

16 and 14 INCH WOOD

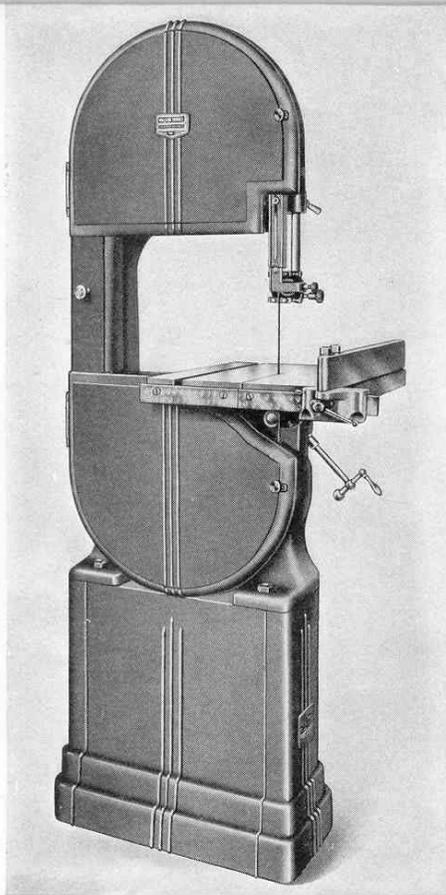

U.S. Pat. No. 1,996,825

- BN1135** 16" Band Saw, as shown, less motor, ripping fence and base. Includes $\frac{3}{8}$ " blade, motor bracket, belt and motor pulley..... **\$142.85**
- KAB55** Special $\frac{1}{2}$ H.P. 1740 R.P.M. Motor, 110-200 volts A.C. 60 cycle..... **35.55**
- 11BN4** Base with motor bracket..... **25.40**
- MG90** Self-indexing mitre gauge..... **5.10**
- 11BN7** Front extension table (14"x10") with rip fence (Fits 16" and 14" models)..... **11.95**
- 9BN58** Support bar for use with 11BN7. **1.80**
- EL5** Flexo Lamp..... **2.55**
- 11BN2** Belt Guard (used when motor is mounted at rear or below)..... **12.35**
- 9BN80** Rip fence and guide bar..... **7.25**

- All wheel bearings heavy duty precision ball bearings
- Tables are heavily ribbed and carefully machined, tilt to 45° one direction, 5° the other
- Wheels carefully balanced and rubber faced
- Blade guides have ball-bearing thrust wheels and oil-impregnated bronze guide blocks
- Blade tensioning devices have spring cushions to absorb shocks
- Guard construction assures complete protection to operator
- 12" capacity on 16" model and 7" capacity on 14" model between upper guides and tables afford unusual capacity
- Heavy cast-iron, one-piece frames have extra strength and rigidity

In hundreds of woodworking plants, pattern shops, vocational schools and general industrial plants these Walker-Turner saws are setting new records of performance, speeding production, or saving money.

Every woodworker will appreciate the extra capacity under the upper guide, the efficient blade-tensioning and wheel-aligning mechanism, the friction-free ball bearing blade guides and the large table areas. These practical features have enabled many shops to replace older, bigger and much more expensive band saws with these Walker-Turner models and save money.

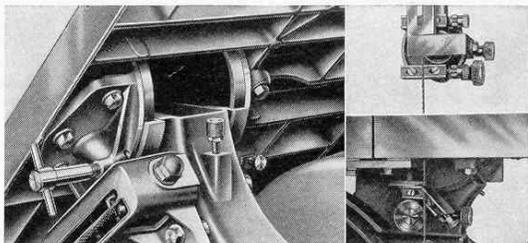

EFFICIENT, BALL-BEARING GUIDES

No skimming on W-T blade guides, the thrust is taken by ball-bearing rollers. Adjustable blocks are made of oil-impregnated bronze to lessen blade friction and reduce heating... another exclusive Walker-Turner feature!

TABLES TILT ON CLOSE FITTING TRUNNIONS

The large heavy tables are rigidly supported by heavy brackets, and tilt on sturdy, close-fitting trunnions. Adjustable stops can be set permanently to the finest degree of accuracy.

Scientific arrangement of table ribs minimizes warping. Soft metal table inserts around blades prevent damage due to accidental contact.

BLADES FOR 16" WOODWORKING BAND SAW				
Catalog No.	11BN25	11BN38	11BN50	11BN75
Width	$\frac{1}{4}$ "	$\frac{3}{8}$ "	$\frac{1}{2}$ "	$\frac{3}{4}$ "
Length	114 $\frac{3}{4}$ "	114 $\frac{3}{4}$ "	114 $\frac{3}{4}$ "	114 $\frac{3}{4}$ "
Price	\$2.75	\$2.75	\$3.20	\$3.20

WOODWORKING PLANTS SAVE MONEY

CUTTING BAND SAWS

SPECIFICATIONS

(16" and 14" Models)

- WHEELS:** Gray iron carefully machined and balanced, rubber faced.
- BALL-BEARINGS:** Large dust-sealed, precision in both wheels.
- GUIDES:** Are both ball-bearing with adjustable oil-impregnated bronze blocks.
- WHEEL GUARDS:** Are cast-iron, hinged for convenience . . . telescoping guards at area of operation.
- ADJUSTING MECHANISM:** For blade and upper wheel mounted on two heavy ground steel rods . . . cushion springs absorb blade shocks.
- MOTOR BRACKET:** At rear of frame supplied with 16" model, for 14" model available as an extra.

	16" Model	14" Model
Capacity, blade to frame.....	16"	14"
Capacity, guide to table.....	12"	7"
Table size	18" x 17"	16" x 16"
Blade speeds, ft. per min., standard motor.....	2900	2535
Machine speeds, R.P.M., standard motor.....	680	680
Height overall, without base.....	50½"	44"
Height overall, with base.....	71½"	65"
Width	30½"	25¾"
Distance front to back.....	22"	20"
Shipping weight, without base or motor, approx.....	370 lbs.	250 lbs.
Shipping weight, with base, less motor, approx.....	510 lbs.	390 lbs.

POSITIVE ADJUSTMENT OF UPPER WHEEL

The blade-tensioning and wheel-aligning mechanism is simple and sturdy. The wheel at bottom, see illustration, controls tracking of the blade while the upper wheel governs blade tension. A cushion spring absorbs shocks.

SCREW TYPE TABLE TILTING MECHANISM

The table is tilted easily and positively by means of the screw feed mechanism shown above. Degree of tilt is shown at all times by an indicating pin. This is used on 16" models only.

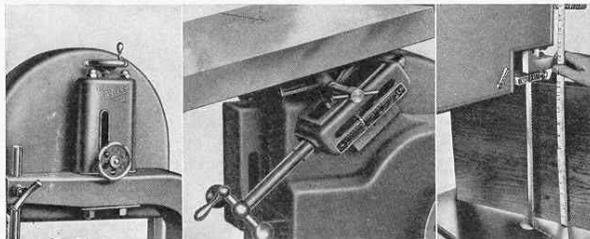

16" MODEL CUTS FULL 12" STOCK

A full 12" cut is possible with the 16" model, 7" being the maximum depth of cut possible with the 14" model. This extra capacity will prove invaluable at times when there are unusually large pieces to be cut. Manufacturers of artificial or dry ice or other bulky products will find these machines well adapted to their needs. The smooth, effortless cutting of the Walker-Turner 16" and 14" band saws is undeniable evidence of great reserve power and strength, finely balanced parts, accurate machine work and correct design.

For complete information of various applications of Walker-Turner band saws see your local distributor.

BLADES FOR 14" WOODWORKING BAND SAW

Catalog No.	9BN25	9BN38	9BN50	9BN75
Width	¼"	¾"	1½"	¾"
Length	96½"	96½"	96½"	96½"
Price	\$1.90	\$1.90	\$2.35	\$2.35

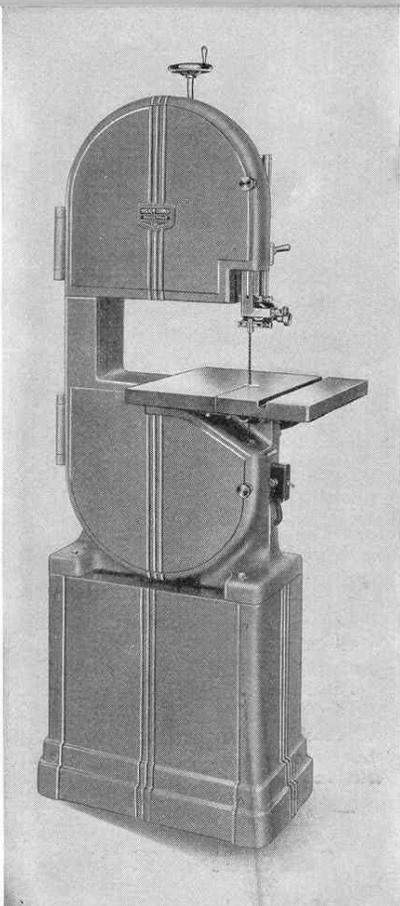

- BN905** 14" Woodworking Band Saw, as shown with belt and motor pulley less motor and motor bracket . . . **\$100.80**
- 11BN4** Base with motor bracket, weight 140 lbs. **25.40**
- 9BN5** Motor bracket for rear motor mounting (not needed with 11BN4). **3.65**
- 11BN2** Belt Guard (used with motor mounted at rear or below). **12.35**
- 9BN80** Steel ripping fence with guide bar. **7.25**
- MG90** Self-indexing Mitre Gauge **5.10**

WITH WALKER-TURNER BAND SAWS

12" BAND SAW

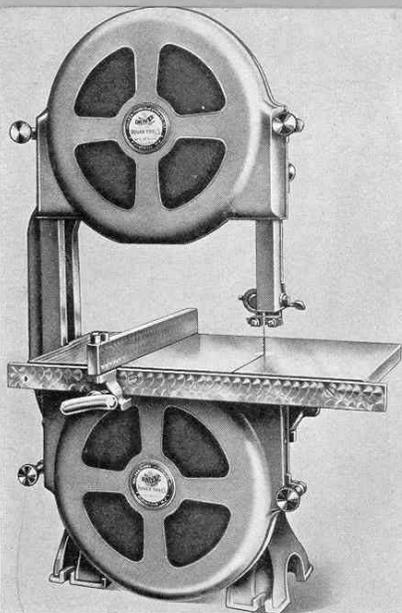

- One-piece cast-iron frame cored for greater strength and rigidity
- Heavy pressed steel 12" wheels carefully balanced, running on oversize ball bearings enclosed in dust-proof housings
- Blade guides have ball thrust bearings and oil-impregnated bronze blocks
- Improved, highly efficient blade tensioning and wheel aligning device
- Cast-iron table, carefully machined, tilts to 45°
- Hardwood table extension increases width of table to 18"

The smooth, powerful action of the 12" band saw has won for it a position of unusual popularity not only in the home workshop but in commercial plants as well. Its fine cutting qualities are apparent in all kinds of work, whether it is cutting sharp corners in light stock or hogging its way through a 4" walnut butt.

Guards, ripping guide and table extensions are regular equipment making this the most completely equipped band saw built. Compare this band saw to any other 12" model on the market. Only then can you realize how superior it actually is . . . how much extra value is built into it.

BN730 12" Band Saw, as shown including all guards and ripping fence.
 Belt and motor pulley extra . . . \$50.75
PV25 2½" V Pulley50
VB42 42" V Belt (for use without stand)1.15
VB44 44" V Belt (used with stand) . . . 1.15
107 Steel Stand14.50
EL5 Flexo Lamp2.55
 (Motor recommended ½ H.P., 1740 R.P.M.)

STURDY TABLE CONSTRUCTION

Note the sturdy construction of the table and tilting mechanism. The hand wheel at the left tilts the table while the one at the right locks it in position. The adjustable stop screw is also shown.

METAL CUTTING BLADES FOR 12" BAND SAW			
Catalog No.	7BN21	JM51A	
Width	½"	½"	
Length	78"	78"	
No. of Teeth per in.	14	8	
Price	\$1.95	\$2.40	

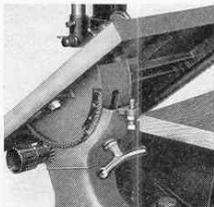

SPECIFICATIONS

WHEELS: Pressed steel, carefully balanced and rubber faced, 12" diameter.

BEARINGS: 2 precision, dust-sealed, ball bearings in each wheel.

FRAME: Cast iron of tubular construction, accurately machined.

TABLE: 12½" x 12", with wood extension 18" x 12" . . . tilts to 45° with geared tilting mechanism. Has soft metal insert around blade to protect it in case of accidental interference with table.

CAPACITY: Upper guide to table 6", blade to frame 12" Removing small guard between upper and lower wheel guards increases capacity above 12".

GUIDES: Ball-bearing upper and lower. Guide pins of oil-impregnated bronze relieve friction and add to life of blade.

RIP FENCE: Solid steel, has sturdy bracket and solid steel guide bar.

GUARDS: Complete set supplied. Wheel guards are detachable separately.

HEIGHT: Overall 33½".

SHIPPING WEIGHT: 103 lbs.

WOODWORKING BLADES FOR 12" BAND SAW			
Catalog No.	7BN17	7BN20	7BN19
Width	¾"	¾"	¾"
Length	78"	78"	78"
Price	\$1.75	\$1.75	\$1.75

NEW STEEL STAND

This new, cabinet type, fully enclosed stand is made of heavy gauge steel. It provides an ideal mounting for the 12" band saw, placing the band saw table at the correct working height. With this stand the AD17 hinged motor bracket is used.

107 Stand for 12" band saw \$14.50
AD17 Hinged motor bracket \$2.55

IMPROVED BLADE TENSIONER

A new method of mounting upper wheel greatly increases rigidity and provides perfect tensioning and tracking of the blade. A coil spring absorbs shocks that might damage blade.

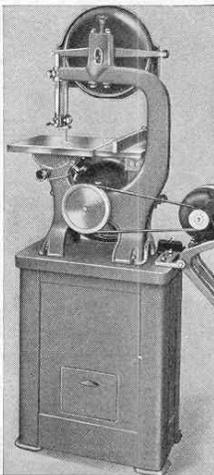

WALKER-TURNER MACHINES PROVIDE

B745 8 INCH BENCH SAW

MANY OUTSTANDING WALKER-TURNER FEATURES

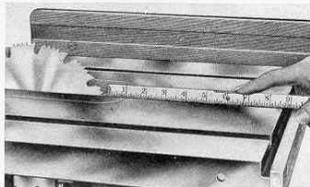

The improved 7B745 saw has 8½" of table space in front of blade. This feature, combined with the overall table size, puts this machine in a class by itself.

Steel rip fence supplied in place of wood-faced fence shown.

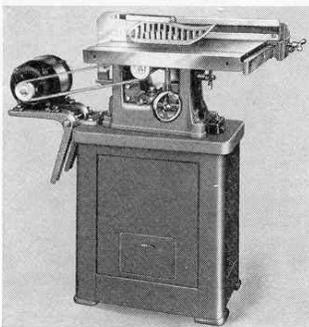

The new heavy gauge steel base, with the AD17 motor bracket, provides the ideal mounting arrangement for the B745 saw.

Steel rip fence supplied in place of wood-faced fence shown.

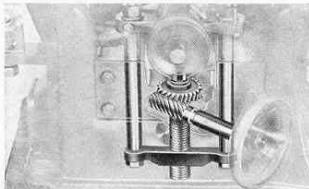

The worm gear raising and lowering mechanism is an exclusive Walker-Turner development. Gears are housed and a hand screw locks gear at any position.

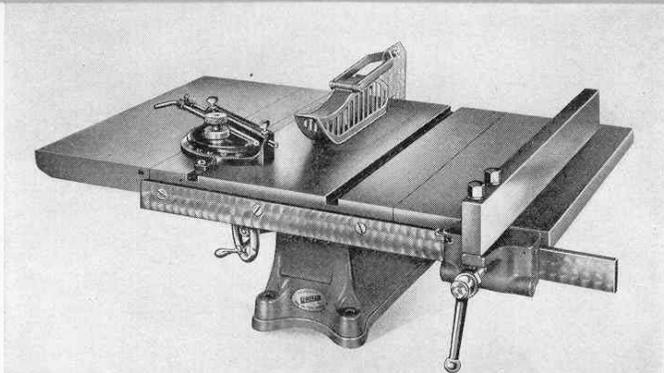

U.S. Pat. No. 2,010,882

B745	8" Bench Saw as shown with steel rip fence, self-indexing mitre gauge and combination blade, but less table extensions, guard and splitter (motor pulley and belt not included)	\$43.45
PV450	4" V Pulley	.65
VB39	39" V Belt	.95
AD17	Motor Bracket	2.55
57	Guard and Splitter	3.65
107	Steel Stand	14.50
7B31	Side table extensions, with long guide bar (pair)	13.80
7B5	Table insert for dadoing	1.15
11BN7	Front extension table (14" x 10") with fence	11.95

See page 19 for listings of saw blades and dados.

- Unusual capacity, depth of cut, 2¼" with 8" blade
- New all steel rip fence may be used on either side of saw blade
- Accurately ground cast-iron table, 19"x15", tilts to 45°
- Heavy saw arbor runs on oversize dust-sealed precision ball bearings
- Fully enclosed worm gear mechanism raises and lowers saw arbor
- Safety guard and splitter available as an accessory
- Self-indexing mitre gauge and new steel rip fence included standard equipment
- Table has soft metal insert removable for dadoing

In the "Series 700" saw strength, simplicity and convenience of operation have been developed to an almost unbelievable degree. Every one of its unique features contributes in a very definite way to sustained accuracy, utility and safety. Its exceptional depth of cut and table area are indications of its extra value.

SPECIFICATIONS

TABLE: Close grained gray iron, top ground smooth and heavily ribbed. Tilts to 45°, a scale indicating the degree of tilt. Table insert quickly removable for dadoing.

SIDE EXTENSIONS: For table with long guide bar available as an accessory.

TABLE SIZE: Without extensions, 19" x 15" . . . with extensions 19" x 31".

RIP FENCE: Heavy gauge steel, may be used on either side of blade.

BEARINGS: Large, deep groove, precision ball bearings, dust sealed.

ARBOR: Raised or lowered by enclosed worm gear.

GUARD: Light weight metal affording full protection.

SPLITTER: Holds guard in place and spreads saw kerf slightly to minimize binding.

BASE: Heavy cast-iron carefully machined. Has sawdust chute.

MITRE GAUGE: Geared self-indexing type.

BLADE: Combination 8" diameter blade with ¾" hole.

CAPACITY: Cuts full 2¼".

CUT-OFF WHEELS: For cutting metal and ceramics, available as accessories.

MOTORS RECOMMENDED: For light work 1½ H.P. 1740 R.P.M. (use 4" pulley), for heavy work ½ H.P. 3400 R.P.M. (use 2½" pulley).

SHIPPING WEIGHT: 100 lbs.

OUTSTANDING VALUE AT LOW COST

WALKER-TURNER PORTABLE

NEW MODEL
TEXROPE DRIVE

NEW MODEL
GEAR DRIVE

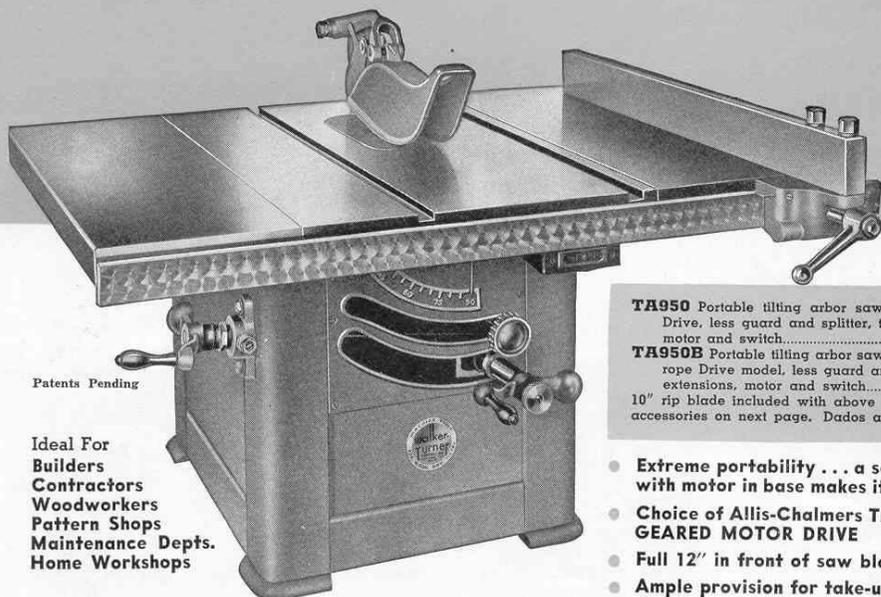

Patents Pending

Ideal For
Builders
Contractors
Woodworkers
Pattern Shops
Maintenance Depts.
Home Workshops

TA950 Portable tilting arbor saw, Geared Motor Drive, less guard and splitter, table extensions, motor and switch..... **\$71.80**
TA950B Portable tilting arbor saw, as shown Texrope Drive model, less guard and splitter, table extensions, motor and switch..... **79.75**
10" rip blade included with above models. Motors and accessories on next page. Dados and blades, page 19.

- Extreme portability . . . a self-contained unit with motor in base makes it readily portable
- Choice of Allis-Chalmers **TEXROPE DRIVE** or **GEARED MOTOR DRIVE**
- Full 12" in front of saw blades
- Ample provision for take-up and adjustment due to wear

- Heavy cast-iron and steel tilting assembly . . . an entirely new development . . . is perfectly balanced and so designed that it cannot be sprung or twisted out of alignment
- New gun type elevating mechanism is simple and strong. Turning the control crank in one direction raises as well as lowers the arbor. Cannot jam!
- Positive locks do not throw any strain on mechanism

- Saw spindles on both **TEXROPE** and **GEAR DRIVE** models are unusually large and turn on heavy duty precision ball bearings
- The entire operating mechanism is attached to the underside of the table eliminating the possibility of misalignment between table and blade
- The new kick-back guard and splitter is a definite safety factor
- A ripping fence of new design

is locked or unlocked on guide bar by less than a half-turn of the control lever.

- Automatic self-indexing mitre gauge included as regular equipment
- Heavy welded steel base fully encloses and protects complete mechanism. Provision is made for bolting to bench or sub-stand
- Table extensions available at extra cost make it possible to rip to center of 48" panel.

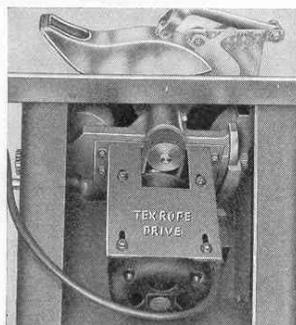

Patents Pending

TEXROPE DRIVE

The well-known Allis-Chalmers **TEXROPE DRIVE** employing three belts and three-groove pulleys is available for those who prefer a belt drive machine. It operates quietly and smoothly with ample overload capacity for production work.

GEARED MOTOR DRIVE

Walker-Turner geared motors have been the sensation of the woodworking industry for the past two years. Never before has such a combination of power and efficiency been available for the woodworking industry. W.T geared motor units provide the most satisfactory drive from the standpoint of efficiency, dependability and freedom from upkeep. See page 18 for complete information. Illustration shows the general design of W.T geared motors as used on circular saw applications.

GEAR DRIVE

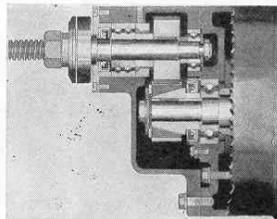

Patents Pending

A cone clutch built into one of the gears prevents any possibility of stripping. Gears are guaranteed against tooth breakage under all conditions.

IN THE SHOP OR OUT ON THE JOB

10" TILTING ARBOR SAW

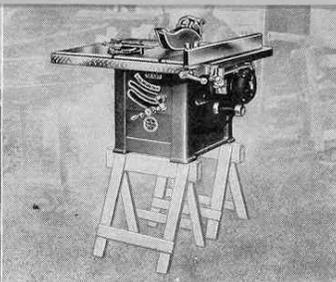
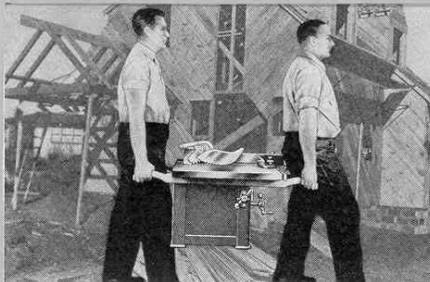

Building contractors will find this new saw far safer and more accurate than portable power hand saws. It will do all the sawing from the cellar to the attic.

SPECIFICATIONS

TABLE: In horizontal position at all times, the arbor tilts. Table is gray iron heavily ribbed for rigidity with top smoothly ground to a plane surface. Mitre gauge slots, one on each side of blade, are accurately milled.

TABLE SIZE: Without extensions 25" x 16"; with extensions 25" x 32".

CAPACITY: Depth of cut with 10" blade over 3" . . . with 8" blade over 2" . . . distance front of table to 10" blade, 12"; distance front of table to 8" blade, 13".

DRIVE: Multiple V belt (Texrope) or geared motor drive optional at slightly different cost.

SAW SUPPORTING UNIT: Consists of two heavy castings carefully machined. Trunnion type suspension is used for attaching unit to table. Unit is tilted to 45° through accurate screw actuated by ball crank. A positive lock is provided.

ELEVATING MECHANISM: Unique, gun type, works on crank and link principle. Turning the ball crank in one direction raises and lowers the blade. Mechanism cannot be jammed.

BALL BEARINGS: 4 precision, SKF's in motor unit carry motor shaft and drive spindle. Belt drive model has two large ball bearings in arbor.

RIP FENCE: Welded steel section, 26" long with quick-acting control lever. Less than a half turn releases or locks the fence.

NEW TYPE GUARD: This guard, with splitter and anti-kick-back pawls gives complete protection.

SUB-BASE: Of heavy gauge steel converts these models into floor models. Available as an extra.

HEIGHT: Overall without sub-base 18", with sub-base 35".

SHIPPING WEIGHT Approximately 210 lbs. less motor.

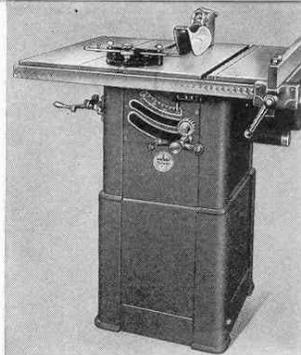

***KEB55** ½ H.P., 110-220 volts, AC, 60 cycle motor with standard switch, used with 8" blade on TA950B.....**\$34.10**

***KEB10S** 1 H.P., 110-220 volts, AC, 60 cycle motor with circuit breaker switch, less air filter, used with 10" blade on TA950B.....**65.25**

3VB16 Set of 3 Texrope belts.....**3.25**

*Because condenser is mounted on the top, one of these motors must be used on TA950B.

GB5 ½ H.P., 110-220 volts, AC, 60 cycles, geared motor with switch, used with 8" blade on TA950.....**\$54.40**

GB10 1 H.P., 110-220 volts, AC, 60 cycle, geared motor circuit breaker switch, air filter for 10" blade on TA950.....**74.70**

AF5 Air filter for motors other than GB10 **2.20**

MBS5 Circuit breaker switch, specify horsepower and type motor.....**8.70**

WELDED STEEL SUB-BASE

Converting the portable saw into a cabinet type saw, this stand is of heavy welded steel construction with a hard wood laminated top bringing the saw table to a normal working height of 35".

19 Stand for portable tilting arbor saw.....**\$13.80**

EXTENSION TABLES

Heavy gauge steel extension tables, 8" wide and 25" long increase the table width to 32".

9TA22 Side Extension tables (with long guide bar).....**\$13.80**

11BN7 Front Extension table (14" x 10") with fence.....**11.95**

ADAPTABLE FOR METAL CUTTING

By substituting an abrasive cut-off wheel for the saw blade it is possible to cut ferrous and non-ferrous metal and various compositions. For accessories see page 19.

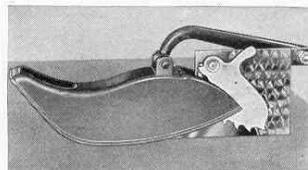
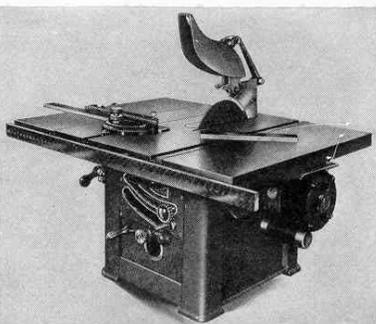

NEW GUARD • SPLITTER

The guard keeps the blade covered at all positions with a minimum of interference. The splitter spreads the saw kerf slightly, reducing the binding that is often encountered when ripping wet or unseasoned stock. The anti-kick-back pawls rest lightly on the stock being sawed and effectively prevent any possibility of its being projected back toward the operator.

TA15 Guard and Splitter.....**\$7.25**
MG90 Mitre Gauge.....**5.00**

SELF-CONTAINED PORTABLE

For the first time builders and contractors are offered a thoroughly practical self-contained saw that is portable,—a saw that has the accuracy and capacity of heavy shop machines yet one that can be transported from job to job. Not only can this machine be readily moved from basement to attic as the job progresses, but it has greater utility than the electric hand saw. It will rip and cross-cut material up to 3" in thickness and dado with or across the grain. Also with a cut-off-wheel it cuts metal moldings, wrought iron pieces and other metallic materials used in building.

THIS SAW QUICKLY PAYS FOR ITSELF

FLOOR MODEL TILTING

- Air-filtered, geared-power motor with over 300% pull out torque. Allis-Chalmers Texrope Drive also available
- Magnetic overload protection switch positively eliminates injury to motor due to overloading
- Heavy cast iron and steel tilting assembly . . . an entirely new development is perfectly balanced and so designed that it cannot be sprung or twisted out of alignment
- Tilting and raising mechanisms are operated easily
- New gun-type elevating mechanism is simple and strong. *It cannot be jammed!*
- Heavy gauge welded steel base, fully enclosed, with clean-out door at rear
- Vernier adjustment of ripping fence regular equipment
- Ample provision for take-up due to wear. Positive locks do not throw any strain on mechanism
- The entire operating mechanism is attached to the underside of table to eliminate the possibility of misalignment
- Anti-kick-back guard and splitter is a definite safety factor
- A ripping fence of new design is locked or unlocked on guide bar by less than a half turn of the control lever.
- Self-indexing mitre gauge regular equipment

Intensive research and development coupled with the experience gained in manufacturing thousands of tilting arbor saws have made possible this De Luxe Model which is by far the finest machine of its type we have ever produced. Through simplification and standardization of design we have been able to effect economies which enable us to market it at an unbelievably low price . . . far below what you would expect to pay for a machine of its qualifications.

TA1180 Floor model tilting arbor saw (geared motor drive) as shown less geared motor and switch, extension tables, guard and splitter . . . **\$113.10**

GB10 1 H.P., 110-220 volt, 60 cycles, AC, geared motor with magnetic circuit breaker switch and air filter. . . . **74.70**

TA1180B (Same as TA1180 but with Texrope Drive). **119.65**

KEB10S 1 H.P., 110-220 volt, 60 cycles, AC motor with circuit breaker, less air filter for TA1180B **65.25**

3 Phase Motors Also Available.

11TA33 Extension tables, three, one 32"x14½", one 32"x8" for sides and one extension for front or rear of main table 20"x5" **19.60**

TA15 Guard, splitter and anti-kick-back pawls **7.25**

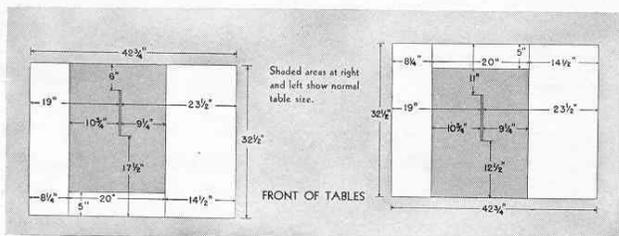

AIR-FILTERED GEARED MOTOR

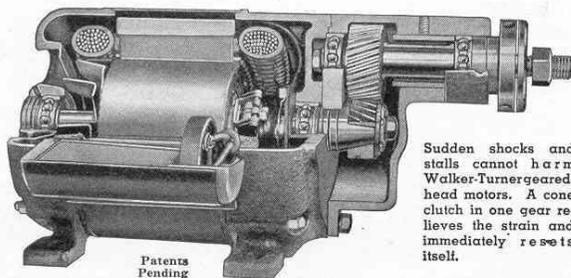

A COMPACT, HIGHLY EFFICIENT MOTOR

Constant research, experimenting and attention to detail have made possible this compact, highly efficient motor. We sincerely believe that no better motor is obtainable at any price. Designed especially for and used exclusively on Walker-Turner machines it has not been necessary to "cut corners" but the designers have had a free hand in developing the best motor for the job.

Sudden shocks and stalls cannot harm Walker-Turner geared-head motors. A cone clutch in one gear relieves the strain and immediately resets itself.

HAS MANY EXCLUSIVE FEATURES

Many are the exclusive features incorporated into its design. High silica steel laminations are annealed after punching. Copper-wound rotors have end rings brazed with silver alloy. Positive, quick-acting starting switch. All electric connections welded, not soldered. These are a few of its high quality features but the most important of all is its efficiency.

MUCH HIGHER EFFICIENCY

These new motors are actually guaranteed to have a pull-out torque of over 300%. This means that the 1 H.P. motor actually delivers approximately 3 H.P. before stalling. At the same time these motors are cool in operation having a temperature rise not to exceed 40° C.

AIR FILTERING DEVICE

All Walker-Turner 1 H.P. single phase, geared motors intended for saw operation have a filter attached to the air intake end bell. This device prevents dust from entering the motor and clogging the starting switch.

WALKER-TURNER SAWS ASSURE YOU

ARBOR SAW

with Air-filtered
GEARED MOTOR



10" MODEL

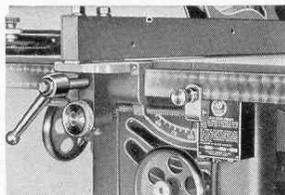

MANY NEW FEATURES

Several exclusive features are shown in the photo above. The magnetic switch that protects the motor from overloading, the Vernier adjustment of the ripping fence, the convenient fence locking lever that releases or locks the fence in less than a half turn, the raising and lowering control wheel and the long steel ripping fence . . . all are features that afford greater utility and convenience.

U.S. Pat. No.
2,016,882
Other Patents Pending



VIEW FROM REAR

A clean-out door in lower rear section of base facilitates the removal of sawdust. Also note the extra table area between saw splitter and rear edge of table top.

SPECIFICATIONS

TABLE: In horizontal position at all times, the arbor tilts. It is made of gray iron heavily ribbed for rigidity with top smoothly ground to a plane surface. $\frac{3}{4}$ " x $\frac{3}{8}$ " mitre gauge slots, one on each side of the blade, are accurately milled.

TABLE SIZE: Without extensions, 20" x 27"; with set of 3 extensions, 32" x 43". The position of extensions can be varied, see sketch on opposite page. Distance from front of table to 10" blade without extension 13", with extension 18".

SAW SUPPORTING UNIT: Consists of two

heavy castings carefully machined. Unit is tilted to 45° through accurate screw actuated by control wheel. A positive lock is provided.

ELEVATING MECHANISM: Unique, gun type, works on crank and link principle. Turning the wheel in one direction raises or lowers the saw blade. Mechanism cannot be jammed.

BALL BEARINGS: 4 precision, SKF, in geared motor carry motor shaft and saw spindle. Belt drive model has two large ball bearings in arbor.

MAGNETIC CIRCUIT BREAKER: This switch

is regular equipment on single phase geared saw motors of 1 and 2 H.P.

RIP FENCE: Welded steel section, 33" long with quick acting control lever. Vernier adjustment of ripping fence is regular equipment.

NEW TYPE GUARD: Splitter and anti-kick-back pawls give complete protection.

CAPACITY: Depth of cut 3".

SAW BASE: Heavy gauge steel of modern design with clean-out door at rear.

OVERALL HEIGHT: Table to floor 35".

SHIPPING WEIGHT: Approximately 315 lbs. less motor.

CUT OFF WHEELS

The metal cutting wheel will cut steel sheets, rods and tubes. The one for ceramics will cut tile, brick and so forth.

G110 8" for metal, bore $\frac{5}{8}$ ".....\$1.95

G111 8" for ceramics, $\frac{5}{8}$ " bore.\$1.95



SAW BLADES

7B15R	8" rip	\$3.25
9B39R	10" rip	4.00
7B15	8" crosscut.	3.25
9B39	10" crosscut.	4.00
7B20	8" combination	3.50
9B37	10" combination	5.00
7B8	8" hollow ground	6.30
9B10	10" hollow ground	8.00

Above blades, $\frac{5}{8}$ " bores.



DADO HEADS

9B36 6" as shown. \$15.60

Consists of:

2— $\frac{1}{8}$ " outside ea.	4.50
1— $\frac{1}{4}$ " chipper	2.20
2— $\frac{1}{8}$ " chippers ea.	2.55
1— $\frac{1}{8}$ " chipper	1.75

D56 $5\frac{1}{2}$ " outside dado, 2 used 2.20

D56A inside chipper .80

All above dados have $\frac{5}{8}$ " bores.

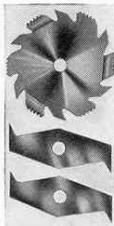

MAINTAINED ACCURACY AND POWER

TWO WALKER-TURNER 6"

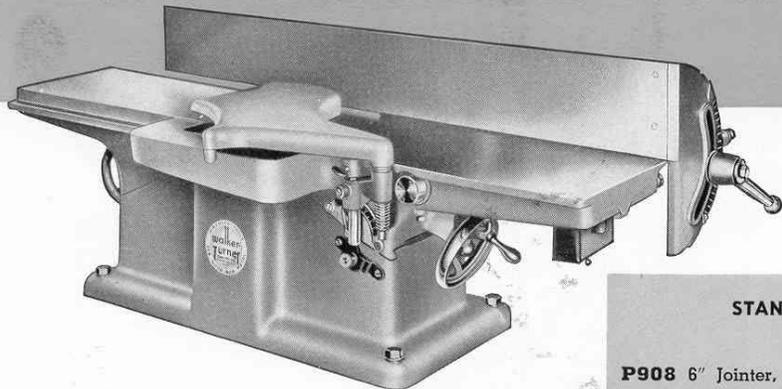

PORTABLE and FLOOR TYPES

In addition to the De Luxe Model, P910, the standard model illustrated above is offered. The machines are identical except for the drive and guard. Both fit 107A stand but when the standard model is mounted on the stand the AD17 motor bracket, page 37, is attached to rear of stand.

- Unit construction with motor attached to jointer base on Texrope model makes for extreme compactness and ready portability
- Texrope drive with triple V belts permits highly efficient, close-coupled motor connection on P910
- New hinged fence with quick-action release lever. Positive, convenient, accurate
- Heavy, accurately machined tables mounted on dovetail ways with adjustable gibs
- Conveniently located motor switch included with motor
- Heavy gauge welded steel base with sawdust chute available . . . stronger than cast iron

STANDARD MODEL

P908 6" Jointer, as shown above with conventional knife guard, less belt, motor pulley and switch. **\$70.35**

PV450 4" pulley, used with 3450 R.P.M. motor **65**

VB42 42" V-belt, used with 3450 R.P.M. motor **1.15**

9P46 Knife guard for rear of fence. **3.65**

KEB5 ½ H.P., 110-220 volts, 60 cycle, AC, 3450 R.P.M. capacitor motor (with remote control switch) **34.10**

KEB3 ½ H.P., 110-220 volts, 60 cycle, AC, 3450 R.P.M. capacitor motor (with remote control switch) **28.30**

FEATURES OF TEXROPE MODEL

PLANES RIBBON THIN!

Notice in the photo that the work is being fed under the dual purpose guard. In this way stock can be reduced to uniform ribbon-thinness with absolute safety. No other jointer has this patented Walker-Turner feature that is endorsed by insurance companies and schools.

HANDLES SMALL STRIPS

Pressure of the thumb on the plunger holds the piece down while the guard itself holds the piece.

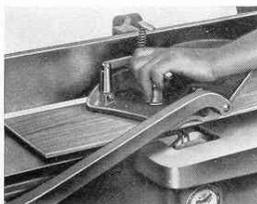

A COMPACT SELF-CONTAINED UNIT

The view shows the new hinged fence, quick-action locking lever, motor mounting, Texrope multiple V belt Drive, rear knife guard that keeps the knives covered when rabbeting and the conveniently located motor switch. Every detail of construction contributes to its sturdiness, accuracy and efficiency.

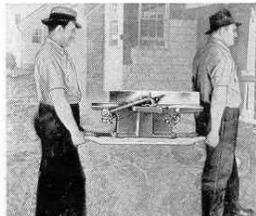

REALLY PORTABLE

For use in different departments or out on contracting jobs.

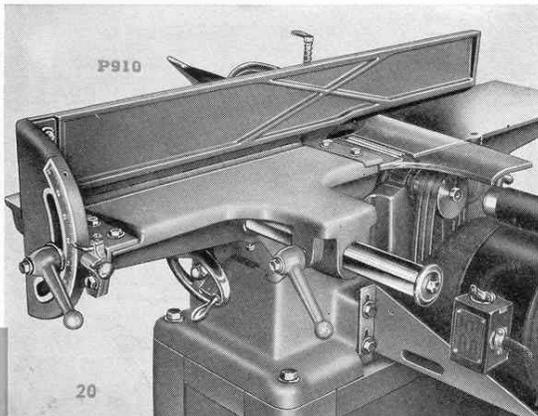

BEST-GUARDED

JOINTERS

TEXROPE MODEL

P910 6" Jointer De Luxe equipment, as shown at right, with MULTIPLE V BELT (TEXROPE) DRIVE motor base and dual-purpose guard, less motor switch and machine base.

\$79.75

9P46 Knife guard for rear of fence.....**\$3.65**

107A Steel stand with chute

\$14.50

KEB55 ½ H.P., 110-220 volts, 60 cycles, AC, 3450 R.P.M. capacitor motor.
\$34.10

DUAL PURPOSE GUARD AN EXCLUSIVE FEATURE

On ordinary jointers the guard simply swings over the knives for protection, but the guard on this jointer performs a double function. It has been so designed that the work may be fed under it while the operator's left hand, resting on the guard applies the necessary amount of pressure. This permits planing wood down to ribbon thickness, with absolute safety. Also, thin narrow strips may be planed down to practically nothing by feeding the strip between the fence and the curved, inner edge of the guard.

NEW QUICK-ACTION LOCK

Less than a half turn of the locking lever locks or releases the fence. Note the readily visible graduated scale and the automatic plunger for locating most-used angles of tilt. Every factor for maximum convenience has been included.

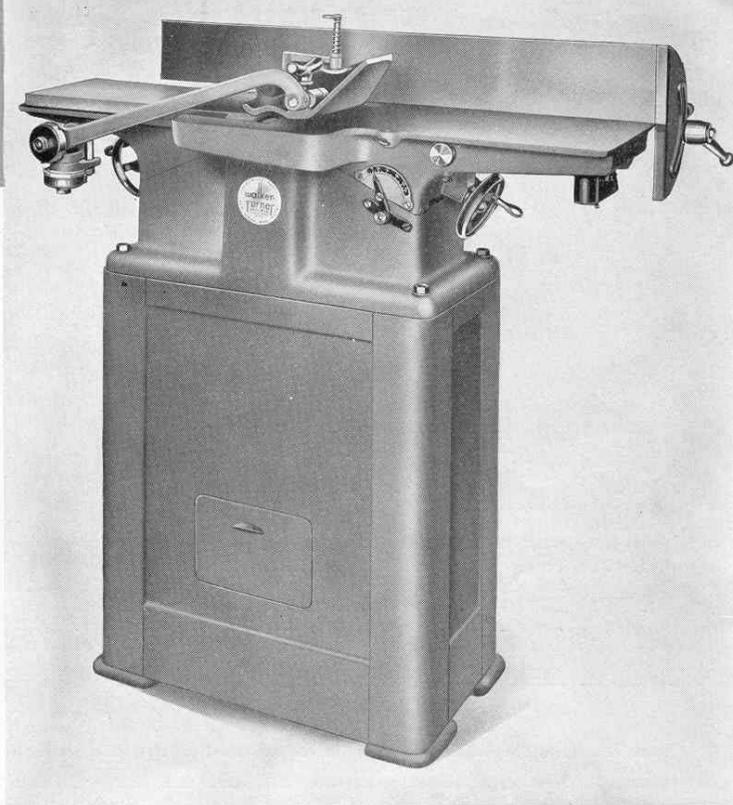
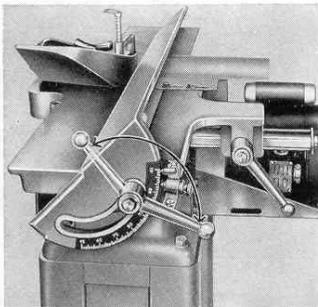

U.S. Pat. No. 2,054,518

SPECIFICATIONS

(Both models)

TABLES: Heavy gray iron cored castings with tops carefully ground. Bottoms have machined dovetail ways to match base. Gibs provided for adjustment.

BASE: Sturdy casting accurately machined. Drilled and tapped for motor base on P910.

CUTTERHEAD: Solid steel carefully machined and balanced. Three-knife, approved round type. 2½" in diameter.

BEARINGS: Precision dust-sealed ball bearings.

KNIVES: Made of selected steel honed to fine edge. Each knife held in position by four jack-screws and provided with a chip breaker.

GUARD: Patented Dual Purpose Guard on P910; conventional type guard on P908.

DEPTH INDICATOR: Accurately shows depth of cut in fractions of an inch.

FENCE: Made of malleable iron, ground and polished, 29½" long, 4¼" high. Indicator shows position in relation to table. Stops provided at 45° and 90° positions. Movable laterally across full width of the table for rabbeting. Control lever locks or releases in less than a half turn. Plunger locates fence at principal positions.

DRIVE: P910 has Allis-Chalmers multiple belt Texrope; P908 has single belt and pulley drive.

RABBETING CAPACITY: Up to ½".

OPERATING SPEED: P910 4200 R.P.M., P908 5000 R.P.M. with 3450 R.P.M. motor.

LENGTH: Overall 37½", front table 17½", rear 15¼".

HEIGHT: From floor to jointer table top 34", machine only 9½".

SHIPPING WEIGHT: P908 approximately 160 lbs.; P910 approximately 175 lbs. without stand or motor. Stand approximately 55 lbs.

SIX INCH JOINTER AVAILABLE

WALKER-TURNER BELT-DISC SURFACER

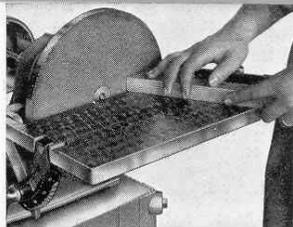
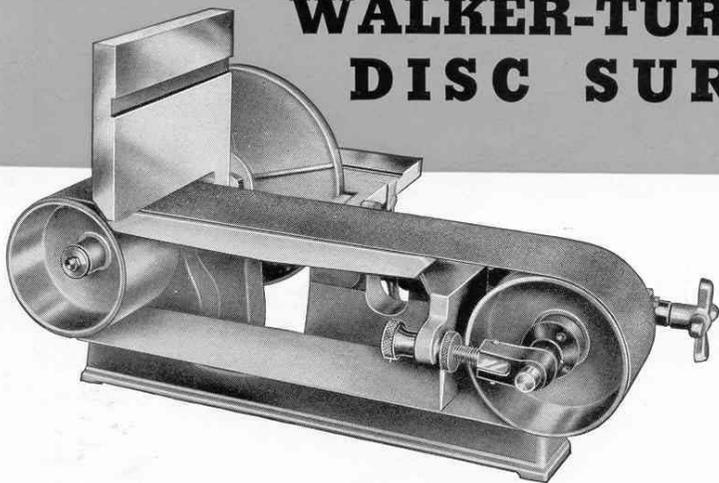

SANDING WITH DISC

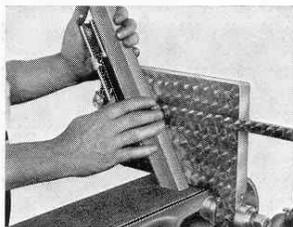

SANDING MITERED JOINT

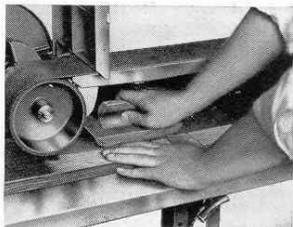

STROKE SURFACING

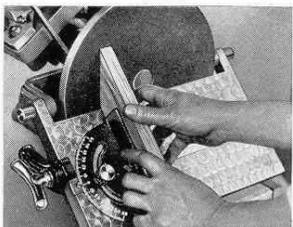

TABLE TILTS TO 45°

- SM700** Surfer (as shown above) includes motor pulley, V belt, hand block and miter gauge. \$43.15
- SM705** SM700 Surfer complete with steel bench, adjustable shelf and motor bracket (less motor) illustrated below. 60.20
- (Motor recommended—for ordinary work 1/3 H.P. 1740 R.P.M. For heavy work 1/2 H.P. 1740 R.P.M.)

SPECIFICATIONS

BASE: Heavy cast-iron, accurately machined for various parts. Has built-in drive belt and pulley guard.

BEARINGS: Completely dust-sealed, packed with grease at the factory and require no further attention or lubrication. Four bearings are used.

PULLEYS: Aluminum die castings 5" in diameter, accurately balanced. Drive pulley is rubber faced and slightly crowned.

BELT: Aluminous oxide, fabric backed. Available in three grades of grit, 36, 60 and 120. Regular equipment 60 grit. Belt 4" x 52 1/2". Tension varied by cushion spring control.

SANDING DISC: 10" diameter, cast-iron, carefully balanced.

ABRASIVE: Aluminous oxide, 40 grit, 60 and 80 grit abrasive discs also available.

MACHINE SPEEDS: 765, 1350 and 2275 R.P.M.

ABRASIVE BELT SPEEDS: 1050, 1760 and 3100 feet per minute.

TILTING TABLE: Hinged for disc. Cast-iron with smooth ground surface. 12" x 6", tilts from 90° to 45°, with angle of tilt indicated on graduated quadrant.

MITRE GAUGE: Furnished regular equipment.

SANDING TABLE: (Under the upper section of belt) cast-iron, carefully machined 12" x 4 1/4". Is attached to and adjusts on base. Carries a stop table 8 1/2" x 6", which tilts 90° to 45° with indicator and graduated collar.

PIVOTED BRACKET: With knurled adjusting and lock nuts to control idler pulley alignment.

DISTANCE: Between centers of pulleys 18".

LENGTH: Overall 29".

HEIGHT: Overall 16".

SHIPPING WEIGHT: SM700 (98 lbs.), SM705 (143 lbs.)

FLOOR MODEL

With the special all-steel stand it is possible to do "stroke surfacing" on large panels, up to 12" in width and 4' to 5' in length. The shelf is adjustable up and down for a distance of 14" permitting wood up to that thickness to be sanded.

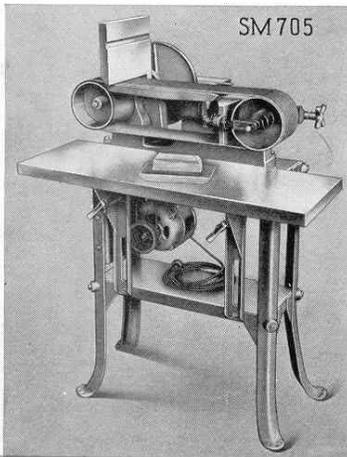

SM705

SAVES ON FLAT OR CURVED WORK

GRINDER-SANDER ACCESSORIES

GRINDING WHEELS

The 4" and 6" grinding wheels as described in the chart at right fit all Walker-Turner grinders except the heavy duty model, GR50, which takes the 7" wheels. These wheels are made of highest quality aluminum oxide chosen for its suitability in grinding edged tools. Of course they may be used also for general purpose grinding. WT grinding wheels are impervious to oil and water. They are all pre-tested as shown by the label to guarantee safety at high speeds. Although the recommended speeds are 3800 R.P.M. for the 4" wheels and 3100 to 3500 R.P.M. for the 6" and 7" wheels, these wheels could be used at higher speeds.

GRINDING WHEELS					
No.	Diameter	Thickness	Grit	Bore	Price
930	4"	1/2"	Medium	1/2"	\$.75
943	4"	1"	Medium	1/2"	.95
G36	6"	1/2"	Coarse	1/2"	1.90
G60	6"	1/2"	Fine	1/2"	1.90
636	6"	3/4"	Coarse	1/2"	2.20
660	6"	3/4"	Fine	1/2"	2.20
GR58	7"	1"	Coarse	3/8"	4.35
GR59	7"	1"	Fine	5/8"	4.35

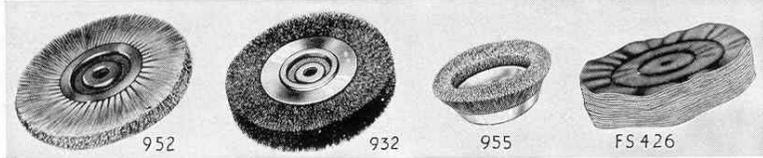
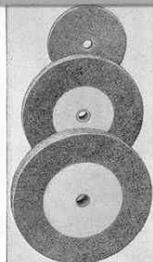

TAMPICO BRUSH

Used on polishing heads, bench grinders and flexible shaft machines. It cleans and polishes giving an exceptionally high finish. The hub is made of steel.

952 6" Brush, 1/2" hole...\$1.55

WIRE WHEELS

Used on bench and motor grinders, polishing head and flexible shafts. 1/2" hole except GR60 which has 3/8".

932 4" Coarse\$.95
 932F 4" Fine 1.45
 950 6" Coarse 1.45
 951 6" Fine 1.90
 GR60 7" Coarse 4.00

WIRE CUP BRUSHES

Instead of having their brushing edge on the periphery, these wire cup brushes have it on the face. This is a distinct advantage on many jobs. Wires are strong and stiff.

955 4" brush, 1/2" hole...\$1.90
 956 2 3/4" brush, 1/2" hole. 1.55

COTTON BUFFERS

Two cloth buffing wheels are available for use on bench and motor grinders, polishing heads and flexible shaft machines. One is 3" in diameter and the other 6". Both have 1/2" holes. They are made of cotton and stitched to medium stiffness for general work. If a thicker section is required, two or three wheels can be mounted together. They may be used for buffing and cleaning metal and for polishing plated work.

FS426 6" Buffer, 1/2" hole\$.90
 931 3" Buffer, 1/2" hole50

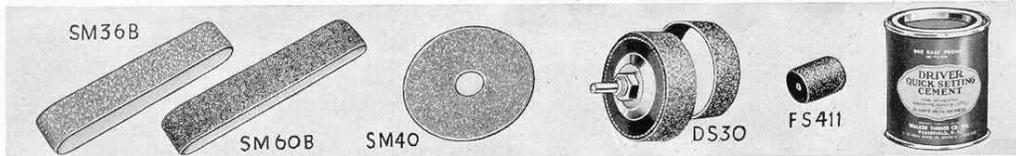

ABRASIVE BELTS

Aluminous oxide, fabric backed for SM700. Endless, 53" long.
 SM36B 36 grit belt...\$1.25
 SM60B 60 grit belt... 1.25
 SM120B 120 grit belt... 1.25

ABRASIVE DISCS

SM40 40 grit, pkg. of 6...\$1.15
 SM60 60 grit, pkg. of 6. 1.15
 SM80 80 grit, pkg. of 6. 1.15

L355 Pkg. of 6 assorted discs for FS413..... .60

SANDING DRUMS •

SLEEVES

DS30 3" x 1" Drum...\$1.55
 DS30C 6 Coarse sleeves 1.00
 DS30F 6 Fine sleeves... 1.00
 DS20 2 1/2" x 1" Drum... 1.10
 DS20C 6 Coarse sleeves .80

DS20F 6 Fine sleeves.... .80
 DS15 1 1/2" x 1" Drum... .65
 DS15C 6 Coarse sleeves .80
 DS15F 6 Fine sleeves.... .80

QUICK-SETTING CEMENT

For holding abrasive discs to wood or metal face plates, and sanding discs.
 FS418 1/2" pt. can.....\$.65

SANDING DRUM

The heavy molded rubber drum is 3" long and 2 1/4" in diameter, has a 1/2" hole but an adapter is supplied for 5/8" threaded spindles.

FS411 Drum with 2 sleeves\$1.90
 FS412 Abrasive sleeves, each20

JIG SAW ACCESSORIES, BLADES

6" FRET AND JIG SAW BLADES						
Cat. No.	Thickness	Width	Teeth Per Inch	Price Per Doz.	Price Per Gross	Used for Cutting
14B	.018	.035	21	\$.50	\$4.35	Wood, veneer, plywood
6J	.017	.035	32	.35	3.65	Metal, hard substances & wood
14J	.010	.045	18	.50	4.35	Wood, veneer, plywood
75J	.016	.054	20	.50	4.35	Metal, hard substances
620	.022	.070	32	.60	5.80	Metal only up to 1/2" thick
410	.020	.072	15	.60	4.35	Metal over 1/2", and wood
610	.020	.110	10	.60	5.80	General purpose, wood, metal
615	.020	.110	15	.60	5.80	General purpose, wood, metal
620	.020	.110	20	.60	5.80	General purpose, wood, metal
410	.028	.187	10	1.30	12.70	Thick stock, wood
S19	.022	%	20	4.00	Steel
FS99	.042	%	9	2.40	Molded brake lining
S16	.040	%	9	.15 each	Sabre blade, for wood
S16	.040	%	9	.15 each	Sabre blade, for wood

AND FILES

MACHINE FILES



Machine files are used on the J782 Jig Saw. Vise No. 514 is required for holding files. 1/8" diameter of shank.

MF1 Three Square File.....\$.90
 MF2 Half Round File..... .90
 MF3 Round File90
 MF4 Crochet File90
 MF5 Pillar File90
 MF6 Square File90

SELECTED FOR HIGH QUALITY WORK

24" DIRECT DRIVE JIG SAWS

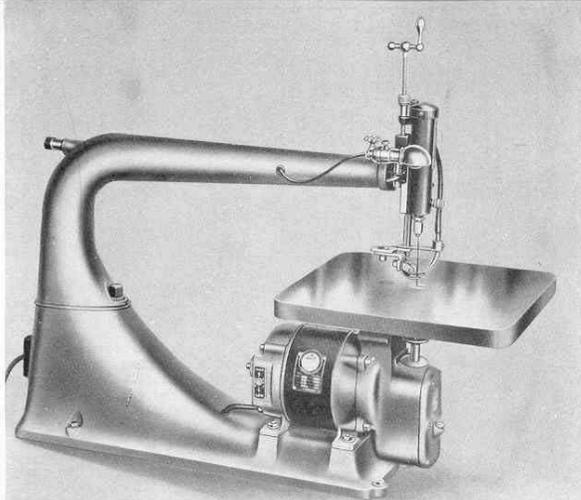

- Direct drive models available in two types, single speed and two speed
- Patented blade tensioner reduces blade breakage and permits varying the tension without stopping machine
- Direct drive mechanism eliminates all pulleys and belts
- Lubrication of entire driving mechanism taken care of at one point
- Blower keeps work cleared of sawdust at all times
- Roller guide accommodates all sizes of blades from the smallest fret blades to saber blades
- Table tilts to 45°, has soft metal insert around blade
- On the two-speed model speeds may be shifted from low to high or high to low without stopping the motor

SPECIFICATIONS

DRIVING MECHANISM: Built in combination with motor to provide direct drive . . . no belt or pulleys. Connecting rod is dropforged, bronze-bushed. Crank pins are hardened and ground steel. Splash system of oiling.

CAPACITY: Throat 24"; upper vise to table with 6" blades 2 3/4", extra capacity if longer blades are used.

TABLE: 15" x 14", machined cast-iron heavily ribbed. Soft metal insert in table around blade. Table tilts to 45° and has graduated quadrant.

BLADE TENSIONER: Adjustable, a few turns of the handle changes spring tension for each size of blade.

HEAD: Bearings are bronze. A blower is built into head and hose directs stream of air onto work.

BLADE VISES: Have positive locks and take plain end blades up to 1/8" wide.

ROLLER GUIDE: Accommodates various sizes of blades.

SPRING HOLD-DOWN: To prevent work being lifted on up-stroke.

HEIGHT: Overall with stand 54", without stand 29".

SHIPPING WEIGHT: Approximately 197 lbs. with stand, 132 lbs. without stand for MJ744. MJ917 weighs 207 lbs. with stand, 142 lbs. without stand.

U.S. Pat. No. 2,116,122, 2,116,123, 2,165,002. Other Pats. Pending

MJ744 24" Direct Drive Jig Saw, as shown above, but without lamp or blade, with single speed motor A.C. 110 volt 60 cycles. (220 volt, 60 cycles, \$3.00 extra; 110 volt, 50 cycle, \$3.00 extra; 3 phase 220 volt, 60 cycles, \$6.00 extra. Not available for D.C.) **\$51.90**

MJ917 24" Direct Drive Jig Saw, as shown, including 2-speed motor. (A.C. 110 volts, 60 cycles only) **64.40**

JL3 Lamp with bulb **2.50**

MJ75 Vises for large blades (used on MJ744, MJ917) **3.15**

JS2 Bench for MJ744 and MJ917. Weight 65 lbs. **13.70**

(For motors of other specifications write factory.)

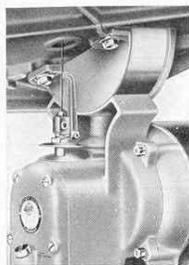
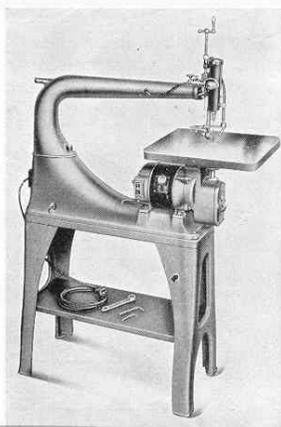

BLADE SUPPORT

This bracket gives extra support to the blade, under the table. It moves with the blade, consequently does not overheat it through friction.

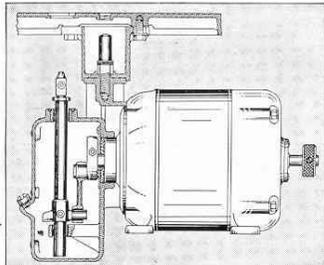

DIRECT MOTOR DRIVE

Mechanism is similar to that of the crankshaft and connecting rod action of an automobile engine. Splash oiling keeps all parts thoroughly lubricated.

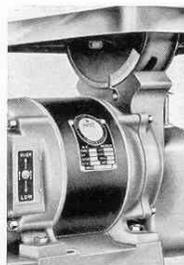

SWITCH

Within easy reach of the operator is the motor switch. A flip from low to high or off to on positions is all that is needed for perfect control.

WALKER-TURNER 1-2-4 SPEED MODELS

24" 4-SPEED JIG SAW

- 4 speeds, 600, 900, 1250 and 1740 R.P.M.
- Patented tensioner minimizes blade breakage
- Large table area, 16"x12 1/2" ... tilts to 45°
- New driving mechanism insures smoother operation

SPECIFICATIONS

NEW DRIVE MECHANISM: Reciprocating type replaces crosshead construction to provide much smoother operation.

THROAT CAPACITY: 24", arm may be swung to either side or removed completely for larger work.

TABLE: 16" x 12 1/2", machined cast-iron, tilts to 45°, has graduated quadrant.

PATENTED HEAD: Same as used on 24" direct-drive models. Capacity vise to table 2 3/4" with 6" blade.

BLOWER: Forces air stream through hose onto work.

OILING: Splash system.

ROLLER GUIDE: Accommodates all sizes of blades and is fully adjustable.

VICES: Large vises, 5J4, are required for sabre sawing and die-filing.

HEIGHT: Overall with bench 50 1/2", without bench 25 1/2".

LENGTH: 33".

SHIPPING WEIGHT: Approximately 180 lbs. with bench, without bench or motor 115 lbs.

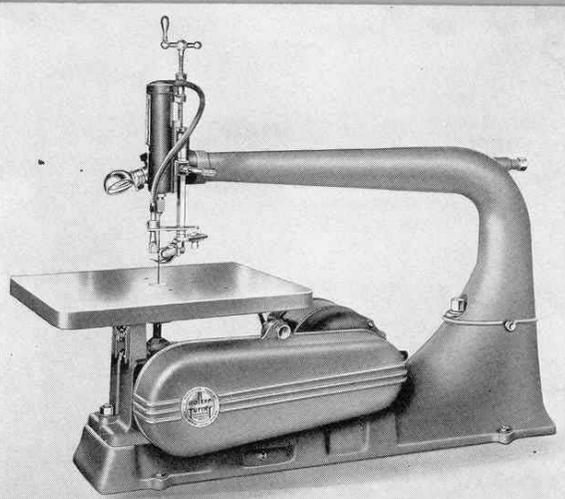

U.S. Pat. No. 2,116,122, 2,116,123, 2,165,002. Other Patents Pending

STURDY PARTS THROUGHOUT

This under-table view shows the rugged table, table bracket, blade vise, main housing and guard bracket, also the convenient location of the motor switch. The superior construction of the base, arm and tensioning device is shown in the photo above right.

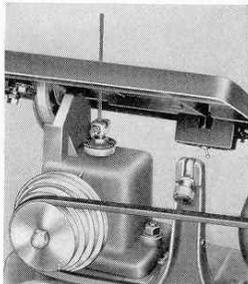

- | | | |
|--------------|--|----------------|
| J782 | 24" belt drive jig saw, as shown, less motor, belt guard and lamp; including motor pulley and 32" belt | \$36.90 |
| 7J125 | Belt guard | 5.00 |
| JL3 | Lamp with bulb | 2.50 |
| 5J4 | Pair of vises for large blades and files..... | 1.95 |
| JS1 | Bench for J782. Weight, 65 lbs..... | 13.70 |

Motor recommended 1/4 or 1/2 H.P., 1740 R.P.M. Do not use a motor of higher speed.



PATENTED TENSIONER

Different sized blades require different tension. The smaller the blade the greater the tension required. With this patented W-T tensioner the tension can be varied without stopping the machine.

SABRE SAWING

Block letters, displays, templates, etc., are easily cut out with sabre blades. Because these blades are heavy they do not need to be held by the upper vise. By removing the upper arm large panels can be handled.

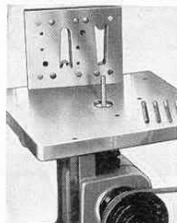
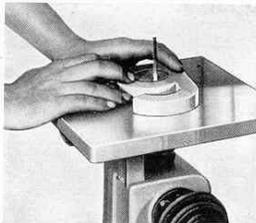

DIE-FILING

This machine has the low speeds necessary for die-filing. This photo shows a die that has been filed on the W-T jig saw. Machine files cannot be used on the MJ744 and MJ917 models.

BENCH

The heavy bench shown at right with cast-iron legs, wood top and shelf, makes the ideal mounting.

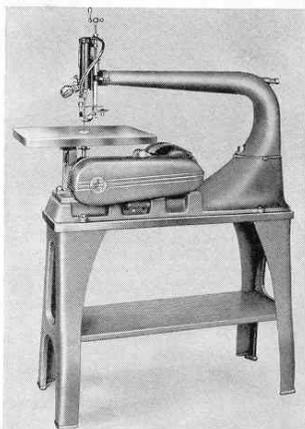

FILL ALL JIG SAW REQUIREMENTS

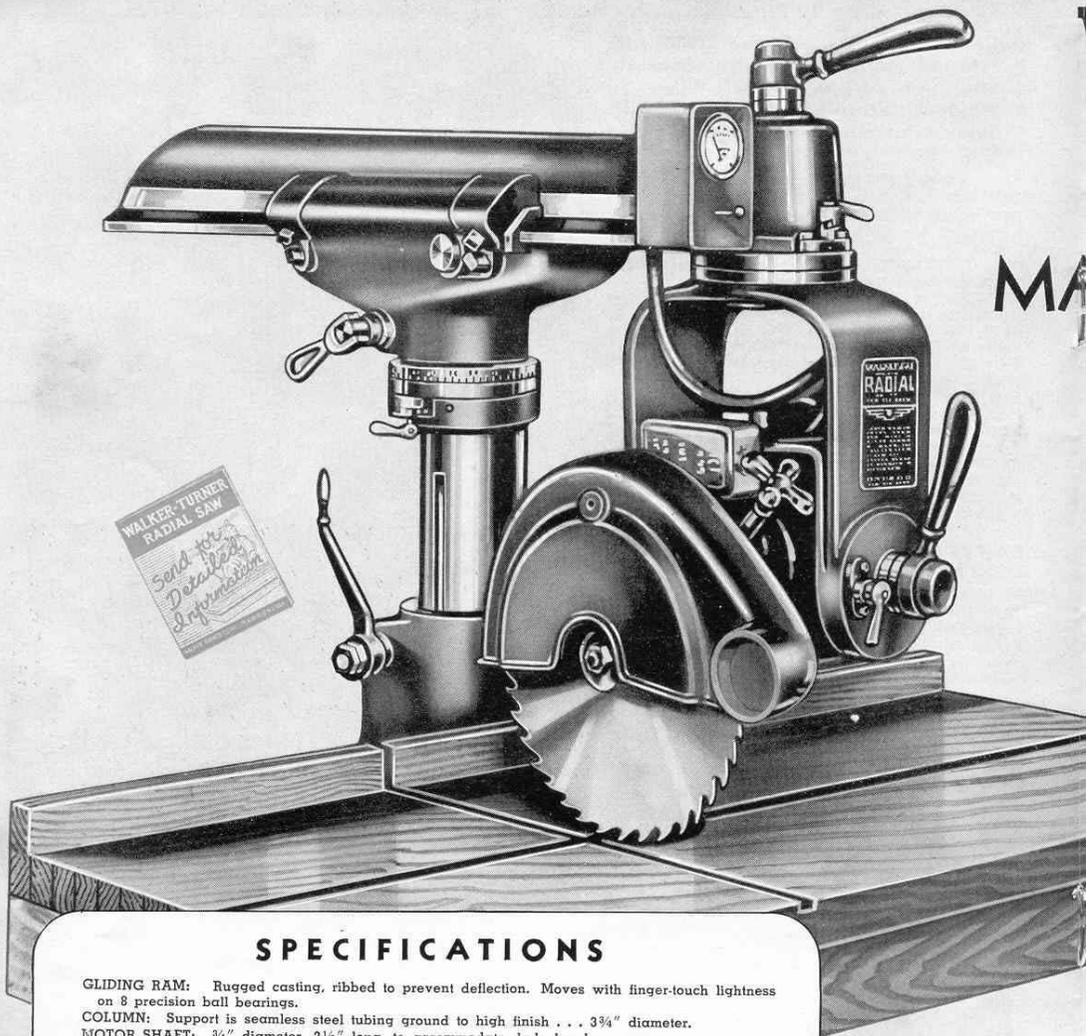

SPECIFICATIONS

GLIDING RAM: Rugged casting, ribbed to prevent deflection. Moves with finger-touch lightness on 8 precision ball bearings.

COLUMN: Support is seamless steel tubing ground to high finish . . . 3 $\frac{3}{4}$ " diameter.

MOTOR SHAFT: $\frac{3}{4}$ " diameter, 2 $\frac{1}{2}$ " long, to accommodate dado heads.

ELEVATING CONTROL: Quick acting, located at right rear section of solid one piece base. Locking lever at left.

RAM AND MOTOR ASSEMBLY: Swivel on steel column, position indicated on scale.

POSITIVE LOCATING LATCHES: On motor unit tilting assembly and yoke swiveling mechanisms.

MOTORS: Geared-head with shock-proof gears available in 1, 1 $\frac{1}{2}$, 2 and 3 horsepower. Magnetic overload release regular equipment on single phase, available for three phase at extra cost.

SAFETY GUARD: Aluminum casting fully adjustable.

LAMINATED TABLE: Of heavy maple has quick change wedges and removable fence. Table size 46" x 24".

VISIBLE VOLTMETER: Indicates line voltage at all times.

CAPACITY: Rips right or left to center of 48" panel. Cross-cut travel, 21 $\frac{1}{2}$ ". Depth of cut 3" with a 10" blade. Compound mitres, 45°, 12" wide. Available with ram for 28 $\frac{1}{2}$ " travel on special order.

BASE PLATE: Supplied with motor for easy removal or attaching. A single nut holds unit in place.

HEIGHT: Overall with stand 63", less stand 34".

DEPTH: Front to back 48".

WIDTH: Left to right 24".

SHIPPING WEIGHT: Approximately 560 lbs.

U.S. Patents Pending



CROSS-C

FOR BUILDER

WALKER-TURNER RADIAL

5
MACHINES
IN
ONE

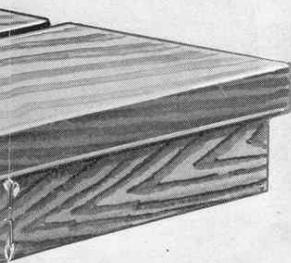

NEW DESIGN A product of modern engineering . . . the new WALKER-TURNER RADIAL combines latest scientific design with older, well-established mechanical principles to meet today's need for MORE SPEED . . . MORE POWER . . . GREATER ECONOMY.

So ingeniously has every detail of design and construction been covered that experts marvel at its efficiency and call it an "Engineering Triumph."

NEW PERFORMANCE Experienced millmen who have always demanded "five-horse" machines because they want to "get the job out" and are unwilling to "coax the saw" will find such power requirements entirely unnecessary with the Walker-Turner Radial. The one element necessary for fast powerful cutting is adequate RIM FORCE . . . power delivered at the tooth of the blade. And here the Walker-Turner Radial greatly excels. With a 1 H.P. Geared Motor it CROSS-CUTS 3 $\frac{3}{4}$ " LUMBER and RIPS 30 LINEAL FEET OF 2" HARD WHITE OAK PER MINUTE. These claims have been proved repeatedly in months of actual operation.

NEW USES The Walker-Turner Radial is a PRACTICAL MULTI-PURPOSE MACHINE. It performs every single operation for which it is recommended accurately, economically and efficiently. All of the tools used for various operations were developed by Walker-Turner engineers for this particular machine. They are made for constant production use, yet sell at unusually low prices. This machine is especially recommended for cutting ferrous and non-ferrous metals. Steel, copper, bronze, aluminum, stainless steel and molded plastic tubes, rods and shapes are cut quickly and accurately on the Walker-Turner Radial.

NEW VALUE Never before has a machine with these features been available at ANY price. To be able to get a machine of this type . . . with its extra capacity and extra power . . . at a price ordinarily asked for "small" models is a remarkable achievement. Only Walker-Turner with its unique engineering, manufacturing and distributing facilities can make such value possible.

Put this machine on your payroll today. It quickly repays its investment and increases profit through the savings it brings.

RA1100 This includes the maple table top, 2 saw blades, safety guard, volt-meter, quick change voltage box, magnetic overload release and wrench and a 1 H.P. single phase geared motor. (F.O.B. Plainfield, N. J.) **\$340.75**



CUTTING

RIPPING

MITERING

DADOING

SHAPING

ROUTING

TENONING

• CONTRACTORS • LUMBER YARDS • WOOD SHOPS • FACTORIES

BENCH MODEL SPINDLE SHAPER

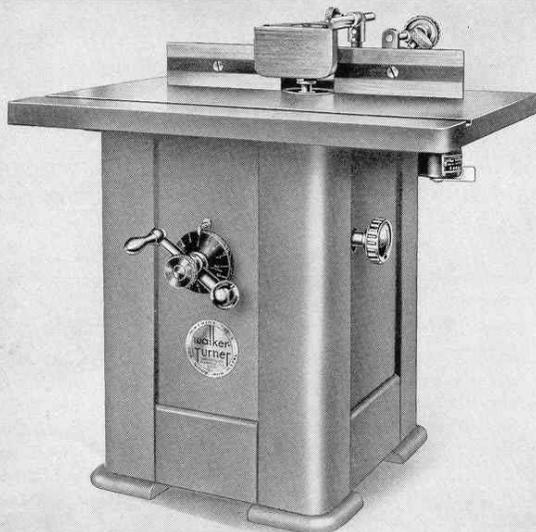

SPECIFICATIONS

(Both Models)

DRIVE: geared motor with operating spindle turning at 7600 R.P.M. through scientifically designed gears.

ARBORS: four interchangeable arbors for $\frac{5}{16}$ ", $\frac{1}{2}$ ", $\frac{3}{8}$ " and $\frac{3}{4}$ " bore cutters are available.

MOTOR AND ELEVATING MECHANISM: securely bolted to underside of table. Heavy cast-iron dovetailed ways with take-up gibs guide motor unit.

BEARINGS: two precision, dust-sealed ball bearings on motor shaft and two on gear shaft.

ELEVATING MECHANISM: motor assembly moved up or down by micromatic mechanism with vernier dial indicator. Travel $2\frac{3}{8}$ ".

REVERSING SWITCH: drum type, conveniently located under the table. Switches included with single phase motors.

TABLES: close-grained gray iron ribbed for rigidity and strength. Top ground and polished. Groove for mitre gauge milled in. Extension table 8" wide available for S975. Attaches to front of table.

STARTING PINS: 2 supplied with floor model. Have tapered ends to fit tapered holes in table. Bench model has single pin with threaded end.

GUARD AND HOLD-DOWN: mounted at rear of table. Spring steel overarm makes effective hold-down while protecting the operator.

GUIDES: made up of two units independently adjustable. Guides on both models have wood facings $3\frac{1}{4}$ " high. Floor model guides are of heavier construction and have provision for an extra lateral adjustment.

SUB-BASE: with laminated wood top available for bench model.

SHIPPING WEIGHT: less motor approximately 145 lbs. for Bench Model and 310 lbs. for Floor Model.

	S750	S975
Table Size	21" x 16"	27" x 20"
Distance,		
spindle to front of table	11 $\frac{1}{2}$ "	14"
spindle to rear of table	3 $\frac{3}{4}$ "	6"
spindle to sides of table	10 $\frac{1}{4}$ "	13 $\frac{1}{2}$ "
Height to top of table	17 $\frac{1}{4}$ "	35"
Shipping weight approx.	145 lbs.	310 lbs.

U. S. Patents Pending

S750 Bench model shaper as shown including arbor for holding $\frac{1}{2}$ " bore cutters, guide pin, a set of spanner wrenches and all guards and guides; less motor and hold-downs.....**\$43.15**

Select motor from the following:

GB55 $\frac{1}{2}$ H.P., geared motor, 110-220 volts, AC, 60 cycles, 7600 R.P.M.... **59.45**

GB105 1 H.P., geared motor, 110-220 volts, AC, 60 cycles, 7600 R.P.M.... **74.70**

Drum type reversing switch included with GB55 and GB105.

5S8 Set of spring hold-downs..... **2.40**

19 Heavy steel sub-base..... **13.80**

9S13 Arbor for cutters with $\frac{5}{16}$ " bore..... **2.55**

9S13B Arbor for cutters with $\frac{3}{8}$ " bore..... **2.55**

9S75 Arbor for cutters with $\frac{3}{4}$ " bore..... **2.55**

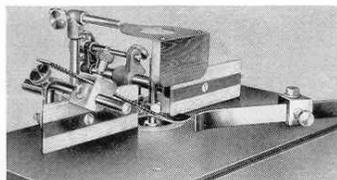

FEATURES OF S750

This photo shows the spring hold-downs, guard overarm and wood-faced, fully adjustable guides. Note the ample working area of table and milled groove for mitre gauge or shaping jig. Many features never before obtained in a shaper of this price class.

REAR VIEW (S750)

Note how completely motor and mechanism are enclosed. Also how fully adjustable are the guides, guard overarm and spring hold-downs.

MOTOR ASSEMBLY BOLTED RIGIDLY TO TABLE

Structural details as illustrated at right with the exception of the hand wheel are common to both "700" and "900" models. Note how the entire mechanism is suspended from under side of table, the dovetailed ways on which the motor is raised or lowered, and the adjustable gibs to take up wear. No detail has been overlooked.

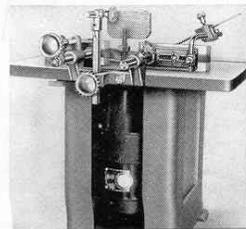
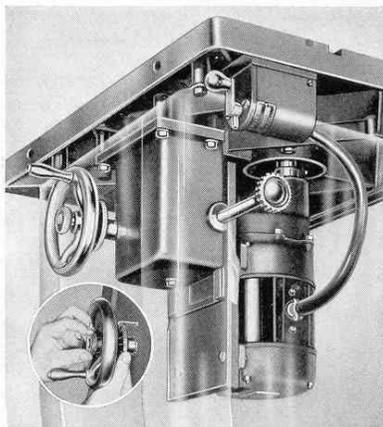

EVERY WALKER-TURNER MACHINE IS

FLOOR MODEL

- Geared motors operating spindles at 7600 R.P.M. assure smooth, fast cutting. No belts to slip or replace
- Reversing switches on both models permit operation of cutters in either direction
- Unique guides are simple, sturdy, and fully adjustable . . . instantly removable for interior work
- Motors and elevating mechanisms are assembled as units and attached to under side of table . . . extremely rigid and compact
- Motors are raised or lowered on dovetail ways with adjustable gibs
- 4 tapered arbors for holding cutters with $\frac{5}{16}$ ", $\frac{1}{2}$ ", $\frac{5}{8}$ " $\frac{3}{4}$ " bore available
- Starting pins for irregular shaped work supplied
- Vernier dial indicator on elevating control can be reset for fine vertical movement
- Bases are extra heavy welded steel construction, stronger than cast-iron. Sub-base available for bench model

S975 Floor model shaper, as shown, including arbor for holding $\frac{3}{4}$ " bore tools, 2 guide pins, a set of spanner wrenches and all guards and guides; less motor and switch **\$126.90**

9S50 Front extension table 8" x 27" cast-iron. **9.45**

9S13A Arbor for cutters with $\frac{1}{2}$ " bore. **2.55**

See opposite page for other arbors

Select motor from the following:

GB10S 1 H.P., geared motor, 110-220 volts, 60 cycles, AC, 7600 R.P.M. **74.70**

GB15S $\frac{1}{2}$ H.P., 3 phase geared motor, 220 volts, 60 cycles, AC, 7600 R.P.M. **79.75**

***GB20S** 2 H.P., geared motor, 220 volts, 60 cycles, AC, 7600 R.P.M. **144.30**

***GB30S** 3 H.P., 3 phase, geared motor, 220 volts, 60 cycles, AC, 7600 R.P.M. **152.25**

* When using GB20S or GB30S specify Machine No. S975L.

Drum type reversing switch included with all shaper motors.

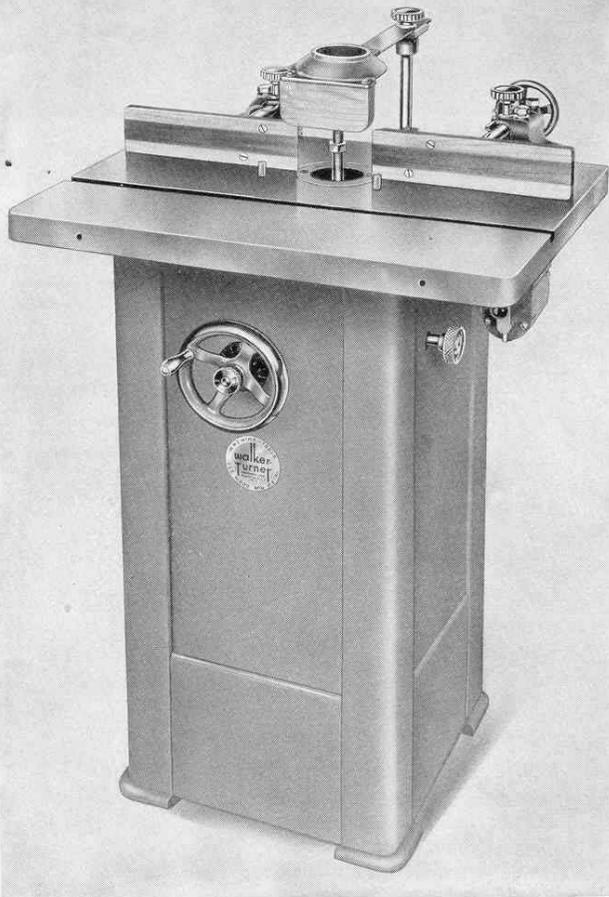

U.S. Patents Pending

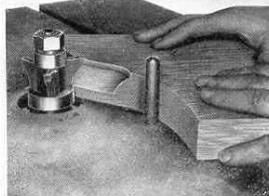
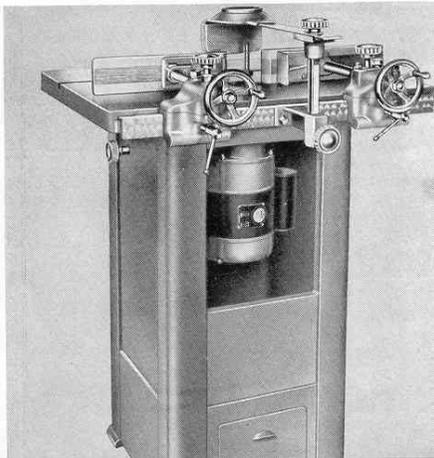

IRREGULAR SHAPING

This work is done without guides using the starting pin and depth collars. Pins are regular equipment.

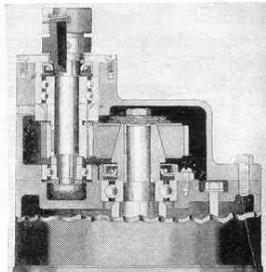

U.S. Patents Pending

GEARED MOTORS • GREATER EFFICIENCY

Loss of efficiency and power and the expense of frequent belt replacement with belt drives is overcome by use of the geared motor. The gear transmission has an efficiency of better than 97%. Its surplus power maintains the constant speed so necessary to smooth, accurate work.

A study of the drawing will show you how completely every detail of mechanical and electrical requirements has been taken care of. The drawing shows the bearing construction of the 2 H.P. geared motor. The $\frac{1}{2}$, $\frac{3}{4}$, 1 and $1\frac{1}{2}$ H.P. geared motors have a single row ball bearing at the spindle end.

A PRODUCT OF MODERN ENGINEERING

SHAPING ACCESSORIES

WIDE VARIETY OF USES

Walker-Turner shapers are not one-operation machines—for shaping only. With their wide selection of accessories they have extra utility, and handle many diversified operations efficiently. They are designed for multiple application. Besides shaping they may be used for sanding, dadoing, tenoning, reeding, fluting, panel carving and for making lock corners (used in box and drawer manufacture).

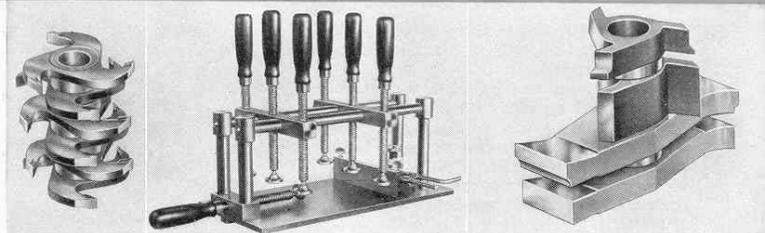

CORNER CUTTERS

These lock joint corner cutters are used for cutting lock corner joints commonly found in the construction of drawer and box corners. The set consists of 6 cutters and spacers. All made of selected steel carefully ground are available with $\frac{5}{8}$ " and $\frac{3}{4}$ " bores. These fine cutters will be found useful not only to the manufacturer or cabinet shop but to the home craftsman.

SS65 Set of cutters, $\frac{5}{8}$ " hole **\$15.90**

SS67 Set of cutters, $\frac{3}{4}$ " hole **15.90**

SHAPING JIG

Greater safety and accuracy when shaping across the grain or handling small pieces are assured with this attachment. The work is clamped in position on the jig and the whole assembly slid through the mitre gauge slot.

Used on S975 Shaper for holding work to be shaped across the grain or for cutting lock corner joints. The base is a heavy steel plate and the uprights and bars large diameter steel rods. A self-indexing mitre gauge built in for accurate angle work.

9S15 Shaping Jig... **\$25.40**

SASH CUTTER SET

Adaptable for many kinds of commercial moldings . . . unusually low priced . . . finest quality.

RA23X Sash cutter set, $\frac{3}{4}$ " bore... **\$18.50**

Consists of

RA230-1 Cope and Tenon cutter **6.55**

RA230-2 Rabbeting and Tenon cutter... **6.55**

RA235S $\frac{3}{8}$ " Spacer washer, bore $\frac{3}{4}$ " . **.75**

RA235-3 1" Rabbeting cutter **2.90**

RA235-2 Ovolo Sash cutter (3 wings)... **2.55**

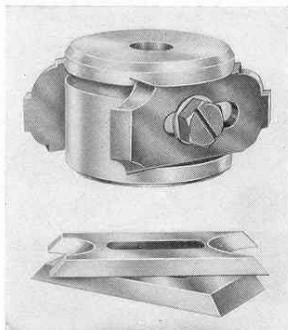

NEWMOLDING HEAD KNIVES

Combining the strength of steel with the lightness of aluminum this new molding head of heat-treated duralumin is approximately one-third the weight of a steel head of similar dimensions. The elimination of needless weight minimizes vibration insuring smoother cuts and more accurate work. The bevelled edged tool steel knives are anchored in position for accurate safe cutting. It is impossible for the knives to fly out because they are held by U-collars and anchor bolts.

RA225 Molding Head (less knives) $\frac{3}{4}$ " bore..... **\$7.20**

RA225-1 Straight-face knives (pair) **\$4.30**

RA225-3 Stair nosing knives (pair) **\$4.30**

RA225-6 Radius knives (pair) **\$4.30**

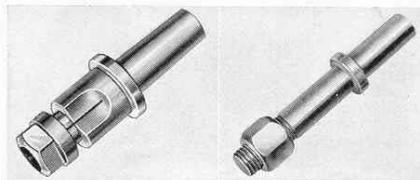

COLLET CHUCKS

The arbors of these collet chucks lock securely in place in the spindle of the shaper. With these collets the carving cutters below, small shaped grinding stones, the DS30, DS20 and DS15 Sanding drums and other accessories having $\frac{5}{8}$ " or $\frac{1}{4}$ " shanks may be used on the shaper.

SS160 Collet Chuck for $\frac{5}{8}$ " shanks **\$6.55**

SS161 Collet Chuck for $\frac{1}{4}$ " shanks **6.55**

D. P. ADAPTER

The $\frac{5}{8}$ " cutters listed on page 31 may be used on the drill press with this $\frac{1}{8}$ " Drill Press Adapter. The cutter is attached to the threaded end and the opposite end held in the collet chuck, 7D11, or in the Jacobs chuck which is standard equipment on W-T drill presses. See page 8 for drill press shaping accessories.

QP120 Adapter for $\frac{5}{8}$ " cutters **\$5.50**

CARVING CUTTERS

Fine carvings can be made with the cutters illustrated above. All of the cutters excepting CR5 screw on to the threaded shank CR7.

CR1 Liner **\$2.75**

CR2 Half Round..... **2.75**

CR3 Round Nose..... **2.75**

CR4 Hook Tool..... **2.75**

CR5 Button Drill..... **2.75**

CR6 Straight Face..... **2.75**

CR7 Ext. Shank $\frac{1}{8}$ " diam. for Holding Cutters.... **.80**

COPE CUTTER AND ARBOR

This combination is used for sash work. Cope cutter screws on to threaded end of arbor which slides into hollow spindle of S975 Shaper motor.

SS62 $\frac{1}{2}$ " Cope Cutter, with arbor and lock screw **\$6.90**

SS62A $\frac{1}{2}$ " Cope Cutter only..... **2.20**

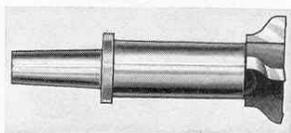

MORE PROFIT FOR YOU WITH W-T

3 WING SHAPING CUTTERS

Walker-Turner 3-wing cutters are made from selected tool steel, accurately ground and carefully tempered. They have three cutting edges and are made in one piece. This type cutter is by far the safest to use.

For use on both the Shapers and the Radial these accurately ground cutters may be used

single or in combination. Besides the cuts made with single cutters many others can be formed by using various combinations mounted together on the arbor.

The variety of shapes plus the low prices make these cutters ideal for use in forming commercial moldings.

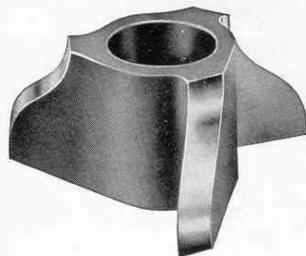

These cutters have 2 bores, $\frac{5}{8}$ " and $\frac{3}{4}$ ". SS51 has a $\frac{5}{8}$ " bore. If this type cutter is wanted with a $\frac{3}{4}$ " bore put a "9" before the number ... as 9SS51.

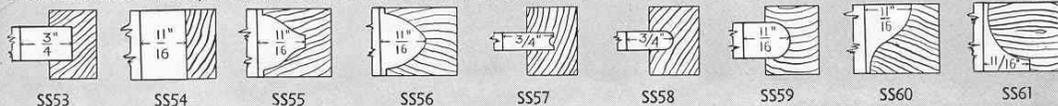

$\frac{5}{8}$ " BORE SHAPING CUTTERS

SS51 $\frac{1}{8}$ " Straight face cutter.....	\$2.20	SS55 1" Double ogee cutter.....	\$3.25	SS59 $\frac{1}{2}$ " Cove cutter	\$2.90
SS52 $\frac{1}{4}$ " Straight face cutter.....	2.20	SS56 1" Round Nose cutter.....	3.25	SS60 1" Ogee cutter	3.25
SS53 $\frac{1}{2}$ " Straight face cutter.....	2.20	SS57 $\frac{1}{4}$ " Bead cutter	2.20	SS61 1" Quarter Elliptic cutter.....	3.25
SS54 1" Straight face cutter.....	3.25	SS58 $\frac{1}{4}$ " Cove cutter	2.20	SS64 Set of 5 depth collars.....	2.55

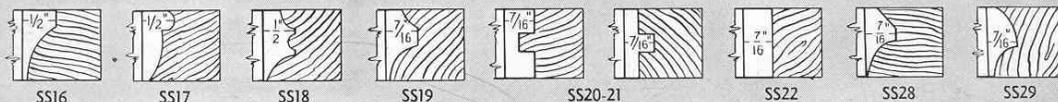

$\frac{1}{2}$ " BORE SHAPING CUTTERS 1" FACE

SS16 Shaper cutter	\$1.45	SS20-SS21 Set of two matched $\frac{1}{4}$ " tongue and groove cutters, set.....	\$2.90	SS26 $\frac{1}{2}$ " Straight face cutter.....	\$1.45
SS17 Shaper cutter	1.45	SS22 1" Straight face cutter.....	1.45	SS28 1" Joint Bead cutter.....	1.45
SS18 Shaper cutter	1.45	SS25 $\frac{1}{4}$ " Straight face cutter.....	1.45	SS29 1" Joint Cove cutter.....	1.45
SS19 Shaper cutter	1.45			SS50 Set of 5 depth collars.....	1.10

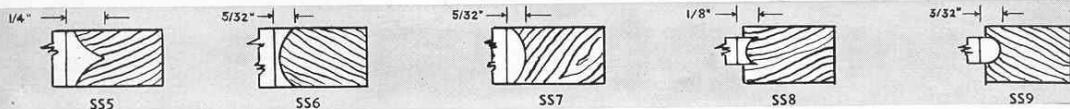

$\frac{5}{16}$ " BORE SHAPING CUTTERS

SS5 Fluting cutter $\frac{3}{8}$ " face.....	\$.80	SS7 Cove cutter $\frac{3}{8}$ " face.....	\$.80	SS9 Cove cutter $\frac{3}{8}$ " face.....	\$.80
SS6 Corner rounding cutter $\frac{1}{16}$ " face....	.80	SS8 Corner rounding cutter $\frac{3}{8}$ " face....	.80	SS14 Set of depth collars.....	50

HIGH-QUALITY KEEN-EDGED TOOLS

LATHES FOR WOODWORK-

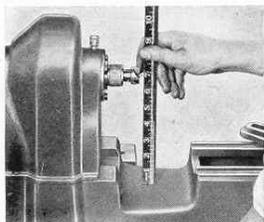
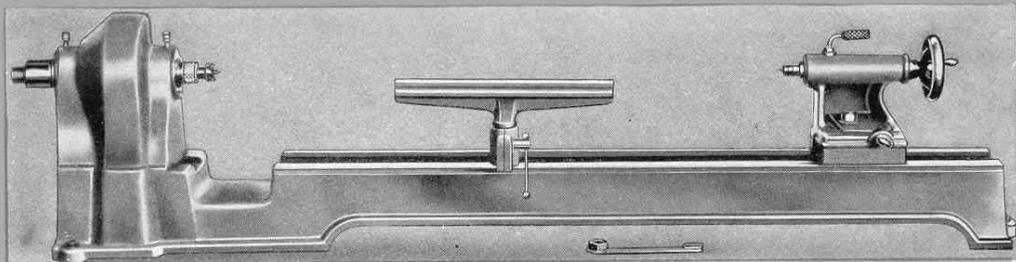

13 1/2" CAPACITY

The distance from center of spindle to the gap section of the bed is 6 3/4". Because of this feature it is possible to turn face plate work up to 13 1/2" in diameter.

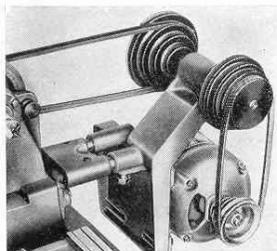

16 SPEED BRACKET

This 16 speed motor bracket attaches directly to the lathe bed. It includes all necessary belts and pulleys. Speeds 240, 360, 440, 510, 660, 710, 760, 930, 1150, 1300, 1400, 1670, 2040, 2260, 2950, and 4000 R.P.M. with 1740 R.P.M. motor. (Fits L752 and L905 Lathes.)

9L50 16 speed Motor Bracket. \$11.55
5L52 16 speed Bracket for "500" lathe 10.90

also needed. A special 1" tap is available for cutting threads in wooden forms so they may be screwed directly to the headstock spindle. The view at right shows a bead being turned on the rim of a shallow dish with the aid of the heading tool. The craftsman who likes to work in metal has great possibilities open to him in making spun articles from pewter, copper and brass. A wide variety of work—either for decorative or utility use—can be spun on Walker-Turner "700" and "900" lathes.

L752	Lathe as shown. Includes 39" V belt, 12" and 6" tool rests and box wrench. (Motor pulley extra).....	\$54.40
PV62	5 1/2" 4-step pulley (for 5/8" motor shaft).....	1.75
PV500	5 1/2" 4-step pulley (for 1/2" motor shaft).....	1.75
9LB15	Bench for L752 lathe.....	25.40
9L1G	Belt guard (from headstock to jackshaft). See Illustration Page 34	7.25
9L81	Belt guard (from jackshaft to motor). See Illustration Page 34. (Motor recommended 1/3 H.P. 1740 R.P.M.)	6.55

- Headstocks have two sets of pre-loaded precision ball bearings with deep groove races (a double row at the right end of the spindle and a single row at the other)
- Ample overload capacity for both thrust and radial loads is provided
- The headstock spindle, which is hollow, is one inch in diameter between bearings
- All head and tail stock centers have No. 2 Morse Tapers
- Headstock spindles are held to very strict tolerances for run-out
- Designed and built to meet exacting requirements with extra strength and rigidity throughout
- 4 speeds are available using the lathe as set up; 16 speeds are available by adding the 9L50 16-speed motor bracket listed at left

TWO ALL-PURPOSE LATHES

They embody all worthwhile features of wood-working lathes, with compound slide rests they are equipped for metal turning.

While the gap bed feature of the "700" model was developed primarily for metal spinning this extra capacity near the headstock will be appreciated by the woodworker who has large diameter faceplate work to turn. A full line of tools available on page 34.

BUILT FOR METAL SPINNING

Because of the extra leverage exerted on headstock and bed, unusual strength and rigidity are essential in these parts when spinning or turning metal. Walker-Turner "700" and "900" lathes, with their massive cast-iron headstocks, tail stocks and beds carefully machined and accurately fitted, are ideally suited to this exacting work. Many other lathes in this price class are entirely unqualified to meet the demands that metal spinning puts upon them.

METAL SPINNING EQUIPMENT

When spinning metal it is necessary to maintain steady, uniform, lateral pressure on the work to prevent it from slipping around. This requires the ball-bearing tail center. A special tool rest which fits into the standard tool rest bracket is used for cutting threads in wooden forms so they may be screwed directly to the headstock spindle. The view at right shows a bead being turned on the rim of a shallow dish with the aid of the heading tool. The craftsman who likes to work in metal has great possibilities open to him in making spun articles from pewter, copper and brass. A wide variety of work—either for decorative or utility use—can be spun on Walker-Turner "700" and "900" lathes.

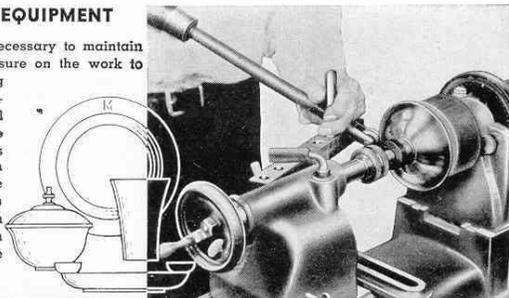

UNUSUAL ACCURACY AND RIGIDITY

ING AND METAL TURNING

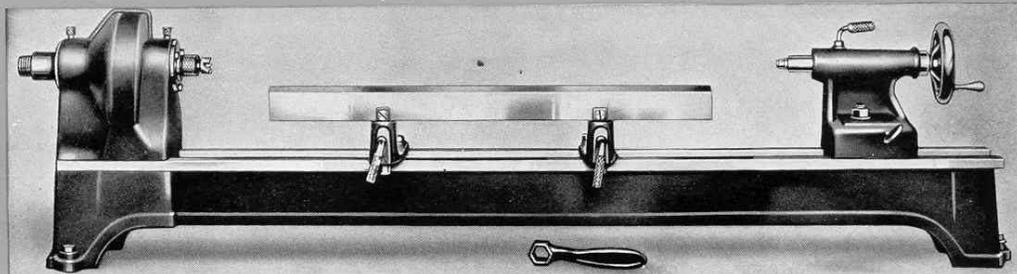

L905	Lathe, as shown, but with 12" tool rest instead of 24" illustrated. 6" tool rest and 39" V belt also included. (Motor pulley extra)	\$71.80
PV62	5½" 4-step pulley (for ⅝" motor shaft)	1.75
PV500	5½" 4-step pulley (for ½" motor shaft)	1.75
9LB15	Bench for L905 Lathe	25.40
9L1G	Belt guard (from headstock to jackshaft). See Illustration Page 34	7.25
9L81	Belt guard (from jackshaft to motor). See Illustration Page 34. (Motor recommended ½ or ⅓ H.P. 1740 R.P.M.)	6.55

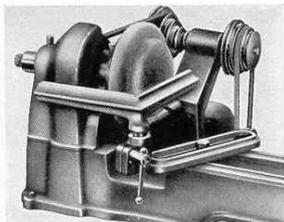

SPECIFICATIONS

BED: L752 has gap bed 5" wide at top. L905 has a much heavier bed 6½" wide at top with widely machined ways. 54" long, carefully machined gray iron.

CENTERS: Distance between 37". No. 2 Morse Taper used.

SPINDLE: Hollow head, ⅝" inside diameter . . . left end threaded for face plate. Diameter of spindle between bearings 1".

BALL BEARINGS: Double row and single row precision ball bearings in head.

SET-OVER: On tail stock for turning tapers.

INDEXING DEVICE: Positive type on headstock for holding turnings stationary while being fluted or reeded.

SWING: Normal 10"; swing at gap on "700" lathe 13½".

SPEEDS: 700, 1300, 2300, 4200 R.P.M.

HEIGHT: Of bed 4¾" on L752, 6¼" on L905; overall 12¾" on L752, 14" on L905.

SHIPPING WEIGHT: L752, 130 lbs.; L905, 180 lbs.

STURDY LATHE BENCH

This bench was developed especially for the Series "700" and "900" lathes. The height can be varied several inches by means of the adjustable legs. Necessary bolts supplied. The legs are heavy cast-iron. Bench is 57" long and 11½" wide. Shipping weight of complete bench 79 lbs.

9LB15 Lathe bench complete...**\$25.40**

BL1 Bench legs only (for above bench) **15.60**

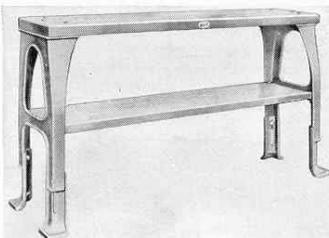

METAL TURNING SLIDE REST

With the compound tool rest shown at left, many metal turning operations such as turning and boring, straight or taper, can be done with great accuracy. The compound rest clamps directly to the bed of the L752 or L905 lathe. All sliding surfaces are precision fitted insuring smooth, positive and accurate action in all positions. It may be set at any angle on the horizontal plane, moved towards and away from the headstock (longitudinally) and crosswise of the bed (transversely). Distance of longitudinal feed six inches, transverse seven inches. All the commonly used attachments for metal turning are available, including face plates, independent and universal chucks, Jacobs chuck, lathe dog, tool holder, bit and steady rest. See page 35 for listing.

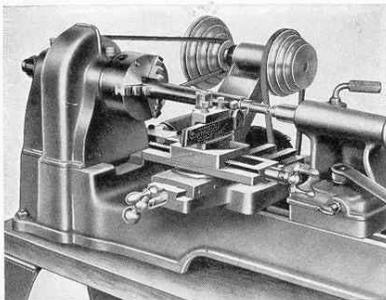

RIGHT-ANGLE TOOL REST

Developed to increase accuracy and convenience of face plate turning. Fits standard bed bracket.

9L88 Right angle tool rest for L752 and L905.....**\$2.20**

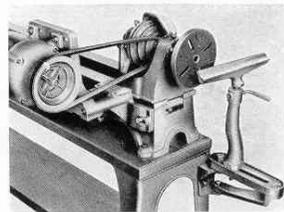

TOOL REST BRACKET

Photo shows the 9L54 outside tool rest bracket used when large face plate work is turned on left end of spindle. These accessories fit the L752 and L905 lathes.

9L54 Outside tool rest bracket including 12" tee.....**\$8.35**

5L51 Direct drive motor bracket (see page 43)..... **4.00**

IN EVERY WALKER-TURNER LATHE

LATHE ACCESSORIES FOR

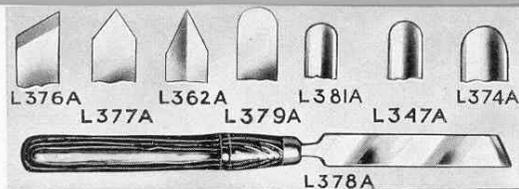

WOODTURNING TOOLS

These turning tools are full size, with blades of selected steel that hold their edges and hard-wood handles that have a natural, perfect grip. The wide selection of types covers all normal turning requirements.

L378A 1" Skew Chisel	\$1.80
L376A 1/2" Skew Chisel	1.15
L379A 1/2" Round Nose	1.15
L362A 1/2" Parting Tool	1.15
L374A 3/4" Gouge Chisel	1.80
L347A 1/2" Gouge Chisel	1.40
L381A 1/4" Gouge Chisel	1.40
L377A 1/2" Spear Point	1.15
L8A Set of eight (as above).....	10.50

HAND-FORGED CHISELS

Developed to fill a demand for a higher quality chisel than has heretofore been available, these hand-forged chisels have quickly earned a place for themselves. Each chisel is forged into shape by hand, then ground individually to a fine cutting edge. They hold their edge much longer, require less sharpening and, as a result, last longer than ordinary chisels. For the operator who has considerable turning to do they will repay the difference in initial cost through time saved.

CH21 1" Skew Chisel	\$2.55
CH22 1/2" Skew Chisel	1.80
CH27 1/2" Round Nose	1.80
CH26 1/2" Parting Tool	1.80
CH23 3/4" Gouge Chisel	2.55
CH24 1/2" Gouge Chisel	1.80
CH25 1/4" Gouge Chisel	1.80
CH28 1/2" Spear Point	1.80
CH29 Set of 8 Hand-forged chisels (as above).....	13.80

BELT GUARDS

These guards cover belts and pulleys with either the SL51 direct drive motor bracket or the 9L50 multi-speed bracket. 9L1G attaches to the headstock with a hinge pin. The guard can readily be swung up exposing belt and pulley. The 9L81 guard covers the pulley and belt between the jackshaft of the multispeed bracket and the motor. This guard hinges at the side for convenience. Both guards are made of heavy metal.

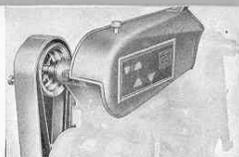

9L1G Belt guard, from lathe to jackshaft.....	\$7.25
9L81 Belt guard, from jackshaft to motor.....	6.55

METAL SPINNING TOOLS

To get the most out of metal spinning, you need good, substantial spinning tools and accessories. These spinning tools represent the types most commonly used and fill all the requirements for ordinary

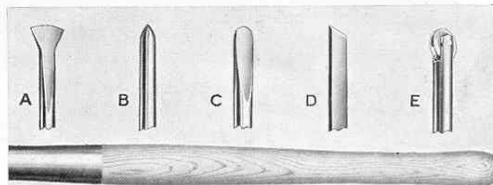

work. Handles are hard-wood 20 1/2" long. Spinning tools are much longer and heavier than turning tools, longer to get the leverage necessary for forcing the metal over the form and heavier so they will not bend under the heavy leverage.

A MS4 No. 1 Flat tool with handle.....	\$3.55
B MS5 No. 1 Point tool with handle.....	3.55
C MS6 No. 2 Flat tool with handle.....	3.55
D MS7 Cut off tool with handle.....	3.55
E MS8 Beading tool with handle.....	4.35

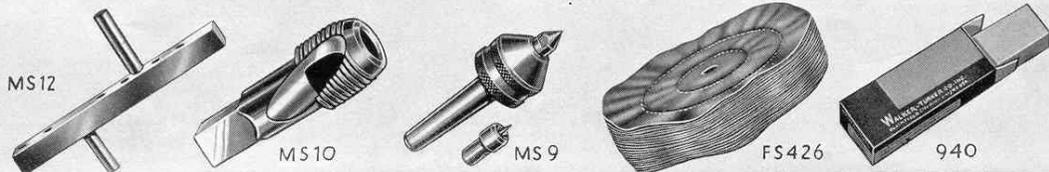

SPECIAL ACCESSORIES FOR METAL SPINNING

Tool Rest

A special, heavy tool rest with movable pin and a row of holes in the top is needed in spinning. Fits into the Series 700 and 900 lathe bed brackets.

MS12 Special Tool Rest. **\$3.20**

12-Thread Tap

A 1", 12-thread tap is helpful for threading wood forms to fit the lathe spindle.

MS10 1", 12 Tap..... **\$4.00**

Ball Bearing Center

Fits 700 and 900 lathes, taking

the place of the regular tail center. 60° and cup centers.

MS9 Tail Center..... **\$7.20**

Cotton Buffer

After work is spun to shape it needs to be buffed and polished to get out tool marks. 1/2" hole.

FS426 6" Buffer **\$9.90**
931 3" Buffer **.50**

Buffing Compound

Buffing compound, used with the cloth wheels, increases cutting speed.

940 Buffing compound..... **\$6.00**

WALKER-TURNER ATTACHMENTS

WOOD AND METAL WORKING

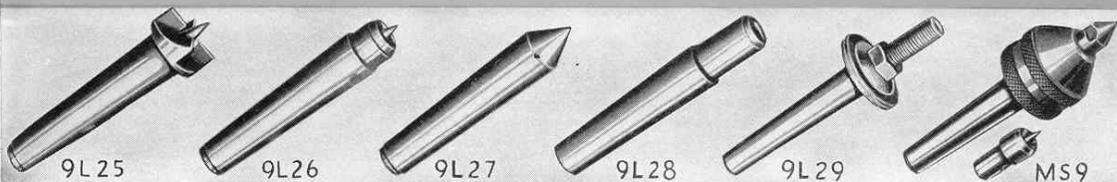

LATHE CENTERS AND ARBORS

SPUR CENTERS

9L25 For "700" and "900"
lathes**\$1.55**
5L5 For "500" lathe..... **1.55**

CUP CENTERS

9L26 For "700" and "900"
lathes**\$1.55**

5L6 For "500" lathe.....**\$1.55**

60 DEGREE CENTERS

9L27 For "700" and "900"
lathes**\$1.55**

5L7 For "500" lathe..... **1.55**

JACOBS CHUCK ARBORS

9L28 For "700" and "900"
lathes**\$1.55**

5L8 For "500" lathe..... **1.55**

THREADED ARBORS

9L29 For "700" and "900"
lathes, 1/2" diam.....**\$1.90**
5L9 For "500" lathe..... **1.90**

BALL-BEARING CENTER

MS9 60° and cup center
points, No. 2 M.T. only **\$7.20**

9L Series Centers have No. 2 Morse Taper; 5L Series Centers have No. 1 Morse Taper.

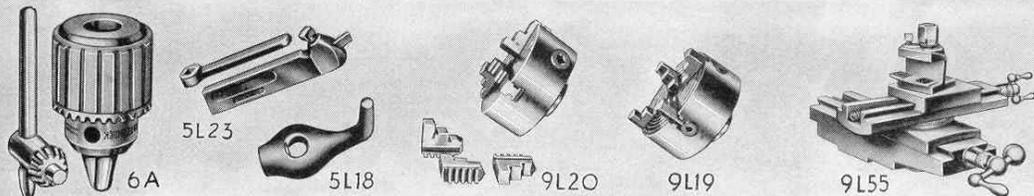

METAL TURNING ACCESSORIES

JACOBS KEY CHUCKS

6A 0" to 1/2" used with
chuck arbors on "500",
"700" and "900" lathes
.....**\$9.80**

33 1/8" to 1/2" used with
chuck arbors on "500",
"700" and "900" lathes
.....**\$8.35**

TOOL HOLDERS

5L23 With bit and wrench.
For 5L63 rest.....**\$3.25**

3/4" LATHE DOG

Used on "500", "700" and "900"
models in conjunction with 6"

face plates for holding metal rods
or tubes to be turned.

5L18 Fits all models.....**\$1.10**

4" UNIV. 3-JAW CHUCKS

9L20 For "700" and "900"
lathes**\$19.60**

5L62 For "500" lathe..... **19.60**

4" IND. 4-JAW CHUCKS

9L19 For "700" and "900"
lathes**\$10.90**
5L61 For "500" lathe.... **10.90**

COMPOUND SLIDE REST

9L55 For "700" and "900"
lathes**\$24.30**
5L63 For "500" lathe.... **22.70**

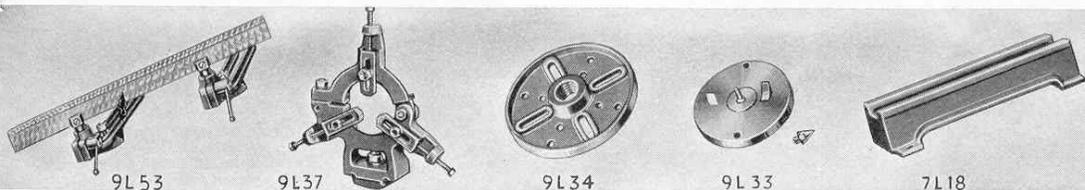

WOOD AND METAL LATHE ACCESSORIES

18" and 24" TOOL RESTS

9L53 24" For "700" and
"900" lathes**\$6.55**
5L12 18" For "500" lathe **3.40**

STEADY RESTS

9L37 For "700" and "900"
lathes**\$6.75**

5L21 For "500" lathe..... **5.60**

FACE PLATE WITH SPURS

9L33 3" For "700" and
"900" lathes**\$2.90**

5L11 3" For "500" lathe..**\$2.90**

EXTENSION BEDS

7L18 18" For "700" lathe..**\$5.95**
5L41 14" For "500" lathe. **2.90**

FACE PLATES

9L34 6 1/4" For "700" and

"900" lathe, left thread..**\$2.90**

9L35 6 1/4" For "700" and
"900" lathe, right thread **2.90**

5L10 6" For "500" lathe,
right thread **1.90**

5L47 6" For "500" lathe,
left thread **2.20**

INCREASE YOUR LATHE'S UTILITY

CUSTOM BUILT • SERVICE TESTED

Many years ago it was apparent to Walker-Turner engineers that something better than ordinary "run of the mill" motors must be developed for powering their wood and metal working machines. Because these motors are often subjected to severe overloading at the hands of inexperienced operators and frequently under most unfavorable conditions the now well-known line of Walker-Turner motors was developed. Designed especially for power tool use they meet the exacting requirements of power tool operation.

Walker-Turner motors are built by expert engineers who personally supervise their manufacture step by step through production. No attempt is made to build them down to a price... yet they are not expensive. Users of Walker-Turner motors have been quick to realize their inherent value and the resulting volume has enabled us to market them at prices almost as low as those of definitely inferior motors.

Walker-Turner motors have extra efficiency and are quiet and cool-running. The 1940 models are the finest motors ever to bear the Walker-Turner name. They cannot be obtained under any other brand name. To get maximum performance and service from your Walker-Turner machines power them with Walker-Turner motors exclusively.

1/4 H.P. DELUXE

This 1/4" H.P. Driver Motor will give you an entirely new conception of what a quarter-horse motor can do. It carries a load with ease that would overload many quarters, and runs cooler at the same time. This motor has ball-bearings, double shafts (1/2" dia.), remote control switch (10 amp.), and No. 18S approved cord and plug. (See illustration at left.)

SAB4 1/4 H.P. 1740 R.P.M. 110 volts, 60 cycles, A.C....\$17.35

1/4 H.P. SLOW SPEED

For slow speed drilling, turning or other operations where unusually low speeds are required, this motor is ideal. Equipped with ball bearings, double shaft (1/2" dia.), remote control switch, cord and plug.

SOB4 1/4 H.P. 1140 R.P.M. 110 volts, 60 cycles, A.C....\$21.70

1/3-1/2 H.P. DUAL-POWER

The Dual-Power Motor is really two motors in one. It has the highly efficient winding of the 1/4 H.P. Deluxe Motor and, in addition, has an equally efficient 1/2 H.P. winding. This unique motor—created in the interest of more economical operation—provides a real saving in power consumption. On ordinary loads it is operated as a 1/2 H.P. with resultant 1/2 H.P. economy. When a heavy load is encountered the switch is snapped over to the 1/2 H.P. side until the load eases. It may be run continuously as either 1/2 or 1/2 H.P. Double shaft, one end 3/8" dia., other end 1/2". It has ball bearings, two-way built-in switch, remote control switch with 30' cord, and standard 10 ft. cord and plug. Reversing switch cannot be used.

SAB35 1/3-1/2 H.P. Dual-Power. 1740 R.P.M. 110 volts, 60 cycles, A.C.....\$25.75

1/3 H.P. DELUXE

Competitive tests prove the Walker-Turner 1/3 H.P. Motor to be much more efficient than the average 1/3 H.P. motor. It is quiet and cool-running and develops far more than its rated horsepower. It is equipped with ball bearings, remote control switch and approved cord and plug. Double shaft with one end 3/8" in dia., the other 1/2" in dia.

SAB3 1/3 H.P. 1740 R.P.M. 110 volts, 60 cycles, A.C....\$20.25

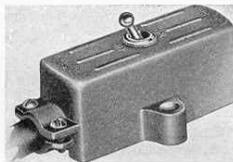

Remote Control Switch

This switch with an extra 30-inch cord is a new Walker-Turner development—standard equipment on practically all motors. The remote control switch makes the use of control rods not only unnecessary, but obsolete.

TS5 Remote control switch, with 30" of rubber covered cord. May be used on any make of single phase motor up to 1 H.P. 220 volts...\$4.00



Location for Lathe

Installed on the lathe bench in front of the bed, the remote control switch affords great convenience to the operator.



Attached to Drill Press

The remote control switch can quickly be attached to drill press heads as illustrated above, or it can be mounted on the bench if preferred.

Push Button Switch

Schools and industrial plants requiring this type switch will find these models fill all requirements. May be mounted on machine or wall and used in connection with circuit breaker switch (not in place of it).

4402 Single phase\$3.65
609 3 phase13.80

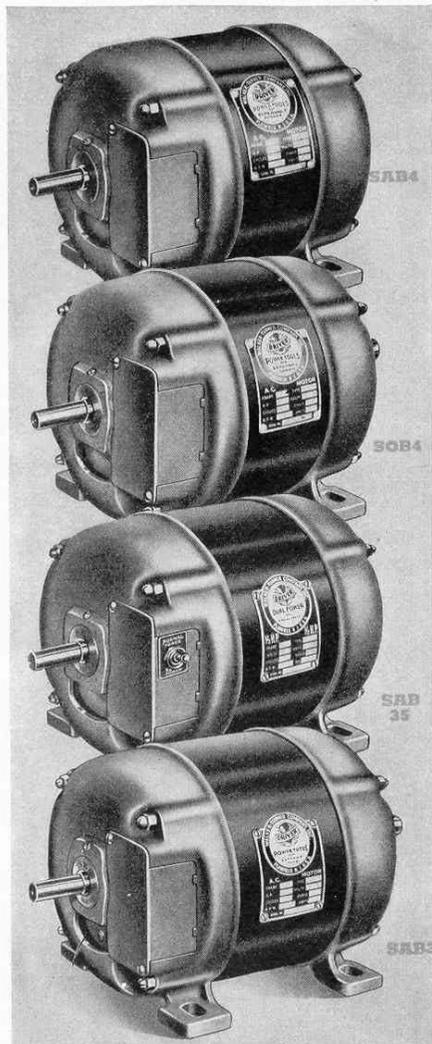

FOR BEST MACHINE PERFORMANCE

MOTORS

- Highly efficient, cool running. Temperature rise not to exceed 40° under full load conditions (unless otherwise noted)
- Every motor guaranteed to develop 2½ to 3 times its horse power rating for intermittent periods
- Motor feet cast integral with end bells. Machined on bottom for uniform height and alignment
- End bells diamond-bored for bearings. Selected precision ball bearings used throughout unless otherwise noted
- Approved switch and 30' extension cord for remote control supplied on practically all models
- All rotors are of copper bar construction. Copper end rings are brazed with silver alloy (not soldered)
- Capacitor start motors wound for 110 and 220 volts

½ H.P. 1740 R.P.M. SPLIT PHASE

This is a split-phase motor having up to 25 per cent overload capacity. It runs cool and does not cause radio interference. It is equipped with ball bearings, remote control switch, 10 ft. approved cord and plug. Double shaft, one ¾" dia., and the other ½" dia.

SABS ½ H.P. 1740 R.P.M. 110 volts, 60 cycles, A.C. \$24.60

½ H.P. CAPACITOR START

A powerful, efficient motor especially adapted to installations where there are hard starting loads. Its low inrush permits it to be used on practically any house circuit. Its speed of 3450 R.P.M. makes it an excellent motor for bench saws and spindle shapers. Equipped with remote control switch, cord and plug. Ball bearings. Double shaft is ¾" dia. at one end, and ½" dia. at the other. Weight 40 lbs. Base 5¼" x 1½".

KEB5 ½ H.P. Capacitor, 3450 R.P.M. 110-220 volts, 60 cycles, A.C. \$34.10



Rocker Type Base

Used on horizontal drives. Weight of motor keeps belt at proper tension.

9P5 Rocket base \$2.40

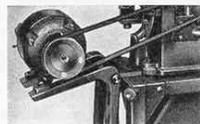

Hinged Motor Base

Ideal mounting with bench saws or jointers.

AD17 Hinged base....\$2.55



Pair of Motor Rails

Motor rails can be mounted at any required distance apart and used with most motors.

MB1 Rails (pair) \$1.15

¾ H.P. CAPACITOR START

This motor has unusual power for its rating. For short periods it develops up to 2 H.P. It operates quietly and economically. For heavy sawing and planing it is ideal. Equipped with remote control switch. Ball bearings, heavy, rubber-covered cord and plug. Double shafts ¾" dia. with keyways and keys. Base 5¼" x 5½". Weight 41 lbs.

KEB7 ¾ H.P. Capacitor start, 3450 R.P.M. 110-220 volts, 60 cycles, A.C. \$47.15

1 H.P. CAPACITOR START

Designed for heavy sawing and other work requiring extra power, this motor delivers much more power than its rating for intermittent periods. It runs cool and quiet—with great efficiency. Regular equipment includes remote control switch, ball bearings, double shafts ¾" dia. with keyways and keys, 10 ft. heavy rubber-covered cord and plug. Base 5¼" x 5½". Weight 62 lbs.

KEB10 1 H.P. Capacitor start, 3450 R.P.M. 110-220 volts, 60 cycles, A.C. \$61.65

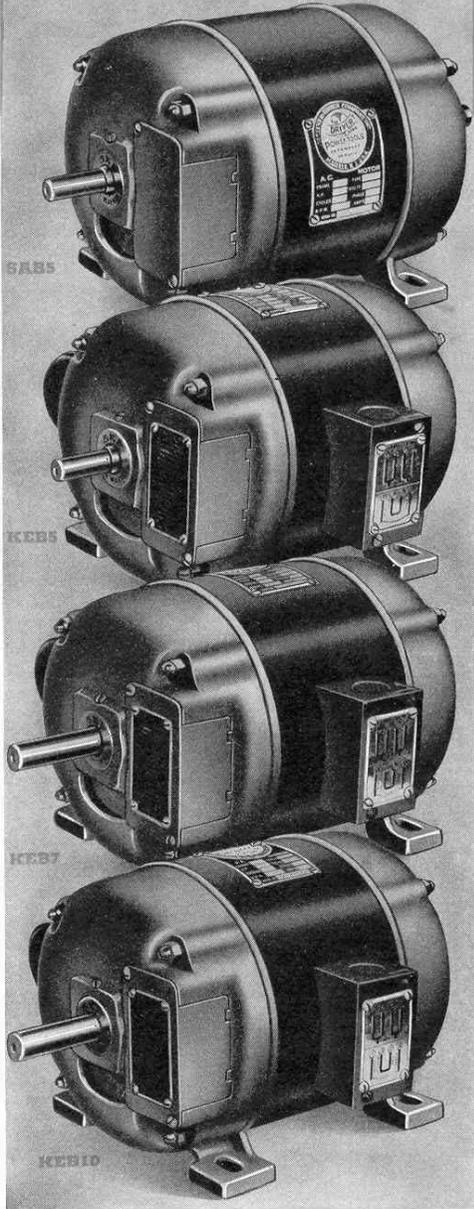

LARGER FRAME SIZE MOTORS

Included in the larger frame size are the following motors: ¾ H.P. 3-Phase, 865 R.P.M.; ¾ H.P. 3-Phase, 1140 R.P.M.; 1 H.P. 3-Phase, 1750 R.P.M. and a 1 H.P. Repulsion-Induction, 1750 R.P.M. For complete specifications see page 40. To mount these motors on W-T machines use adapter NB23A, \$1.10.

USE W-T MOTORS EXCLUSIVELY

GEARED MOTORS FOR

1/2, 3/4, 1 & 1 1/2

Horse Power

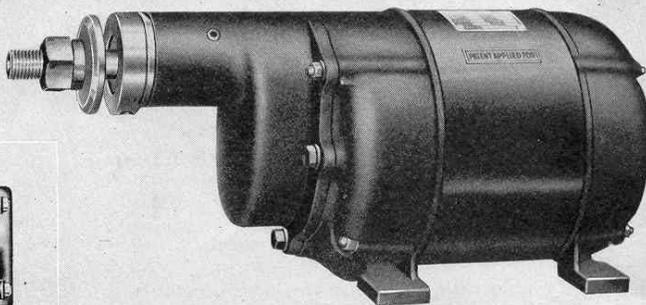

U.S. Patents Pending

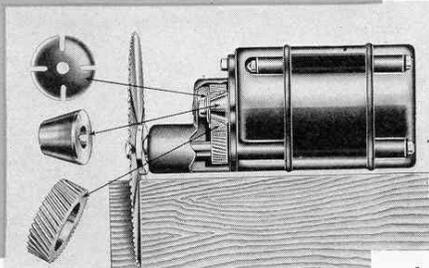

POSITIVE PROTECTION

For the first time complete mechanical and electrical protection is afforded motor users thru two exclusive features built into W-T geared motors. When a geared motor is suddenly stalled a terrific impact is thrown on the gear teeth resulting from the inertia stored up by the fast revolving rotor. To safeguard their motors under such conditions W-T engineers developed a slip-clutch which is built into one of the gears in each pair. When the shock occurs this gear slips momentarily easing the load on the teeth. No resetting is ever necessary. In the two years this clutch has been in use not a single case of gear breakage has been reported.

MAGNETIC CIRCUIT BREAKERS

Protection for the motor itself against damage due to overloading is supplied by a new type magnetic circuit breaker. This switch permits motor to operate continuously at full load and to carry 2 to 3 times full load for short periods, usually up to 2 or 3 seconds. If the load continues to a point where it would cause dangerous overheating the breaker trips and cuts the motor off the line. The motor may be reconnected immediately.

MBS5 Circuit breaker for single phase motors of 2 H.P. or less.

Specify size and type of motor. **\$8.70**

0362 C. B. switch for 1 1/2 and 3 H.P.

3 phase, 200 volt..... **27.90***

0364 C. B. switch for 1 1/2 and 3 H.P.

440 volts..... **33.35***

*Includes steel enclosures. Specify H.P.

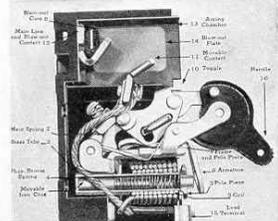

● Improved ventilation insures maximum temperature rise not to exceed 40° C.

- Motors guaranteed to develop 300% of full load H.P. for intermittent service, more than full-rated power for continuous service
- Gears are fabric-impregnated bakelite and steel, protected by a shock-absorbing clutch. Guaranteed for one year
- Selected precision ball-bearings used, 2 on spindle, 2 in motor
- 2 and 3 H.P. motors have double row of bearings on spindle
- Magnetic circuit breaker switch protects motors against overloading
- Cast-iron end bells, gear housing diamond bored to take bearings
- High silica, electric sheet steel laminations in rotor and stator annealed after punching. Rotor of copper bar construction with copper end rings brazed with silver alloy
- Air-filtering device supplied on 1 H.P. geared motors for circular saws; for other motors on special order

A most severe service for fractional and integral horsepower motors is powering relatively small circular saws. Larger machines may be overpowered to a point where motor load is not so severe, but smaller saws, because of portability, must employ motors operating almost constantly under full load. W-T engineers knowing ordinary motors couldn't be expected to give satisfactory results, developed the geared motor. Eliminating belt and pulleys was the greatest step for with gears transmission efficiency of 97-98% was obtained whereas with belt drive losses in transmission often ran as high as 40%. This power saving was put to work at the tooth of the saw.

By constant research our engineers have improved the efficiency to a point where we believe W-T motors are the most compact and efficient made and will develop greater H.P. per pound of material used than any other motor on the market. Geared motors of 1 to 3 H.P. are guaranteed to have a pull-out torque up to 300%, or, a 1 H.P. motor will develop nearly 3 H.P. before stalling. This is true to a greater extent in the 1 and 3 H.P. three-phase motors.

CORRECT DESIGN • CROSS-SECTION

A study of drawing at right will show how every detail of good design has been built into the gear assembly. One of the gears in each pair is made of fabric impregnated with bakelite, the other is steel. This combination affords smoothness, quietness and long life. Large precision ball bearings carry motor shaft and gear shaft, four used. Note cut-away gears and cone clutch elements. These enable us to give a year's guarantee against gear breakage. A special non-fluid lubricant is used in all W-T geared motors.

F927 Non-fluid oil (3450 R.P.M. motors)..... **\$60**

F927S Non-fluid oil (7600 R.P.M. motors)..... **.60**

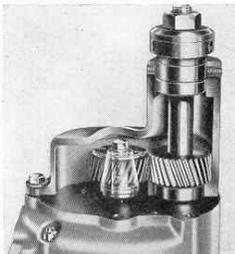

MORE POWER • GREATER EFFICIENCY

SHAPERS AND SAWS

2 and 3 Horse Power

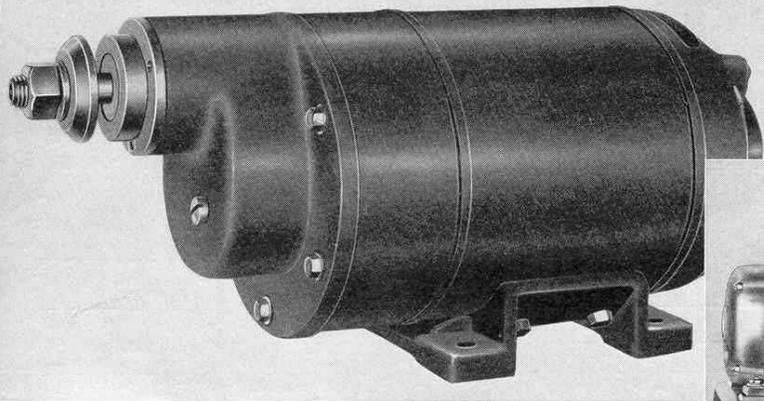

U.S. Patents Pending

Two new additions to the Walker-Turner line of geared motors are a 2 H.P. single phase and a 3 H.P. three-phase motor. These are by far the most powerful motors we have yet produced. They have overload ratings far in excess of those shown on their plates.

While the standard Walker-Turner geared motors have a spindle speed of 3450 R.P.M. with the rotor turning at the same speed the 2 and 3 H.P. models have a spindle speed of 3000. This speed reduction adds greatly to the power delivered at the tooth of the saw blade. Because they are designed to carry 12" blades a spindle speed of 3000 R.P.M. was selected as the best operating speed for that diameter blade. These motors were designed for the Radial Saw and cannot be used on Tilting Arbor Saws. They are also available with a speed of 7600 R.P.M. for use on S975L Spindle Shaper. Magnetic Circuit Breaker switches listed on opposite page.

NEW 1/2 H.P. and 3/4 H.P. SLO-SPEED MOTORS

Primarily for powering the slow speed metal-cutting band saws, these motors can be adapted wherever slow constant speed is required. The motor speed of 1740 R.P.M. is reduced at the operating spindle to a speed of 716 R.P.M. Available in 1/2 H.P. single phase and 3/4 H.P. three phase. See page 10.

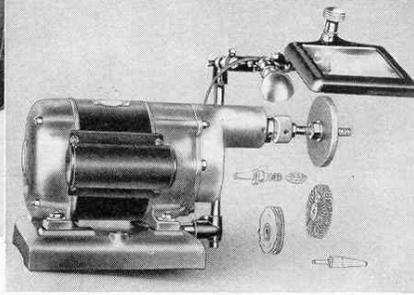

GEARED GRINDER

When equipped with accessories W-T geared motors are portable, accurate and powerful. Plant men find dozens of jobs needing special set-ups incorporating W-T geared motors.

WAC7 3/4 H.P. grinder as shown includes 1/2" threaded adapter, shatter-proof eye shield and SS160 collet chuck less lamp and other accessories**\$108.75**

STARTING SWITCH

An important development used for the first time in any motor to our knowledge is found in the W-T 2 H.P. single phase geared motor. It is the oversize, centrifugal starting switch*, mounted outside the body of motor . . . not inside as is common practice.

One advantage of this new location of the switch is that removing it from the interior of the motor permits a freer flow of air for cooling. Another is that air entering motor often contains fine sawdust which may clog the switch and make it ineffective. The third advantage is that in the event trouble should develop in the switch it is readily accessible without dismantling the whole motor.

* All single phase motors require a starting device which in most instances is a centrifugal switch. Once the motor attains its normal speed the switch cuts out and the motor runs without the use of brushes which require attention and maintenance. Single phase motors have no brushes at all. All capacitor or condenser motors are single phase motors.

CAPACITOR and 3 PHASE GEARED MOTORS

(Dimensions in inches)

- ▲ 3-Phase only.
 - Overload Switch supplied.
 - Drum Reversing Switch supplied.
- 220 to 250 volts \$1.80 extra. 440 volts \$11.60 extra. 3-phase \$8.00 extra. Not available for Direct Current or for 25 and 40 cycles.

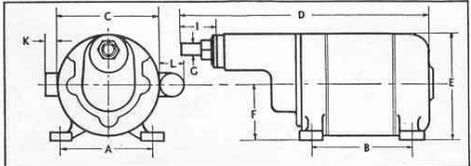

Cat. No.	Key	H.P.	Volts	RPM	Price	A	B	C	D	E	F	G	I	K	L	Wgt.
GB-5		1/2	110-220	3450	\$54.40	5 1/4	5 5/8	6 3/8	14 7/8	6 1/2	3 3/8	3 3/8	1 3/8	1 3/8	2 1/4	60
GB-5S	□	1/2	110-220	7600	66.70	5 1/4	5 5/8	6 3/8	14 7/8	6 1/2	3 3/8	3 3/8	1 3/8	1 3/8	2 1/4	60
GB-7		3/4	110-220	3450	65.25	5 1/4	5 5/8	6 3/8	15 1/2	6 1/2	3 3/8	3 3/8	1 3/8	1 3/8	2 1/4	61
GB-7X		3/4	110-220	7600	70.35	5 1/4	5 5/8	6 3/8	15 1/2	6 1/2	3 3/8	3 3/8	1 3/8	1 3/8	2 1/4	61
GB-10		1	110-220	3450	74.70	5 1/4	5 5/8	6 3/8	15 1/2	6 1/2	3 3/8	3 3/8	1 3/8	1 3/8	2 1/4	68
GB-10S	□	1	110-220	7600	74.70	5 1/4	5 5/8	6 3/8	15 1/2	6 1/2	3 3/8	3 3/8	1 3/8	1 3/8	2 1/4	68
GB-11		3/4	110-220	7600	79.75	5 1/4	5 5/8	6 3/8	15 1/2	6 1/2	3 3/8	3 3/8	1 3/8	1 3/8	2 1/4	68
GB-12		1	110-220	3450	68.90	5 1/4	5 5/8	6 3/8	15 1/2	6 1/2	3 3/8	3 3/8	1 3/8	1 3/8	2 1/4	68
GB-12S		1	110-220	7600	73.95	5 1/4	5 5/8	6 3/8	15 1/2	6 1/2	3 3/8	3 3/8	1 3/8	1 3/8	2 1/4	68
GB-15	△	1 1/2	220	3450	68.90	5 1/4	5 5/8	6 3/8	15 1/2	6 1/2	3 3/8	3 3/8	1 3/8	1 3/8	2 1/4	68
GB-15A	△	1 1/2	220	3450	74.70	5 1/4	5 5/8	6 3/8	15 1/2	6 1/2	3 3/8	3 3/8	1 3/8	1 3/8	2 1/4	68
GB-15S	△	1 1/2	220	7600	79.75	5 1/4	5 5/8	6 3/8	15 1/2	6 1/2	3 3/8	3 3/8	1 3/8	1 3/8	2 1/4	68
GB-20	□	2	220	3000	141.40	5 1/4	5 5/8	8	20 3/8	8 3/8	4 3/4	3 1/2	2 1/2	—	2 1/4	80
GB-20S	□	2	220	7600	144.30	5 1/4	5 5/8	8	20 3/8	8 3/8	4 3/4	3 1/2	2 1/2	—	2 1/4	80
GB-30	□	3	220	3000	141.40	5 1/4	5 5/8	8	20 3/8	8 3/8	4 3/4	3 1/2	2 1/2	—	2 1/4	80
GB-30S	□	3	220	7600	152.25	5 1/4	5 5/8	8	20 3/8	8 3/8	4 3/4	3 1/2	2 1/2	—	2 1/4	80
GTB-5	△	3	110-220	716	72.50	5 1/4	5 5/8	6	14	7 3/8	3	—	1	1	2 1/4	72
GTB-7	△	3 3/4	220	716	79.75	5 1/4	5 5/8	6	15	7 3/8	3	—	1	1	2 1/4	72

WITH W - T GEARED MOTORS

COMPLETE DATA ON DRIVER MOTORS

Factors to be considered in the selection of motors for power tool equipment are the electric current available, type of service, and initial cost. Because of their ruggedness, low maintenance and over-

load capacity, three-phase motors are superior to all other types and their use is recommended wherever three-phase power is available.

Next to the three-phase, from the standpoint of service comes the capacitor-start motor. These motors have a high starting and running torque, low starting current, and are suitable for all types of power drives. Having no commutator or brushes they cause no radio disturbance and their upkeep cost is negligible.

Because of their somewhat lower starting current, repulsion-induction motors are recommended in sizes larger than 1 H.P. when three-phase current is not available.

Split-phase motors have a higher starting current inrush and a lower starting torque than any of the above motors. Consequently they are seldom built in sizes larger than $\frac{1}{2}$ or $\frac{3}{4}$ H.P. Their running torque, however, compares favorably with either the capacitor-start or the repulsion-induction motor, and they are entirely satisfactory where the starting load is relatively light.

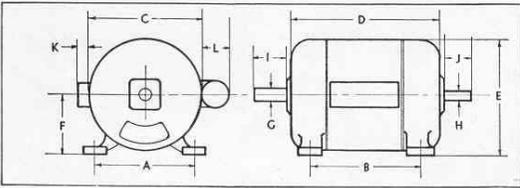

SPLIT PHASE MOTORS (60 CYCLES)

Cat. No.	H.P.	Volts	RPM	Price	Dimensions in Inches											Keyway Width-Depth	Length Keyway	Wgt.	Key to Foot Notes	
					A	B	C	D	E	F	G	H	I	J	K					
S-4	$\frac{1}{4}$	110	1740	10.95	5 $\frac{1}{4}$	3 $\frac{3}{8}$	6 $\frac{5}{8}$	5 $\frac{1}{2}$	6 $\frac{1}{2}$	3 $\frac{1}{2}$	—	—	—	1 $\frac{1}{2}$	—	1 $\frac{1}{2}$	Flat	1 $\frac{1}{2}$	22	#
SAP4	$\frac{1}{4}$	110	1740	15.25	5 $\frac{1}{4}$	4 $\frac{3}{8}$	6 $\frac{5}{8}$	5 $\frac{1}{2}$	6 $\frac{1}{2}$	3 $\frac{1}{2}$	$\frac{1}{2}$	$\frac{1}{2}$	1 $\frac{1}{2}$	—	1 $\frac{1}{2}$	Flat	1 $\frac{1}{2}$	27	#	
SAB4	$\frac{1}{4}$	110	1740	17.35	5 $\frac{1}{4}$	4 $\frac{3}{8}$	6 $\frac{5}{8}$	6	6 $\frac{1}{2}$	3 $\frac{1}{2}$	$\frac{1}{2}$	$\frac{1}{2}$	1 $\frac{1}{2}$	—	1 $\frac{1}{2}$	Flat	1 $\frac{1}{2}$	28	#	
SOB4	$\frac{1}{4}$	110	1140	21.70	5 $\frac{1}{4}$	5 $\frac{1}{8}$	6 $\frac{5}{8}$	8	6 $\frac{1}{2}$	3 $\frac{1}{2}$	$\frac{1}{2}$	$\frac{1}{2}$	1 $\frac{1}{2}$	—	1 $\frac{1}{2}$	Flat	1 $\frac{1}{2}$	40	#	
SAB3	$\frac{3}{8}$	110	1740	20.25	5 $\frac{1}{4}$	4 $\frac{3}{8}$	6 $\frac{5}{8}$	7 $\frac{1}{4}$	6 $\frac{1}{2}$	3 $\frac{1}{2}$	$\frac{1}{2}$	$\frac{1}{2}$	1 $\frac{1}{2}$	—	1 $\frac{1}{2}$	Flat	1 $\frac{1}{2}$	28	#	
SEB3R	$\frac{3}{8}$	110	3450	27.20	5 $\frac{1}{4}$	4 $\frac{3}{8}$	6 $\frac{5}{8}$	7 $\frac{1}{4}$	6 $\frac{1}{2}$	3 $\frac{1}{2}$	$\frac{1}{2}$	$\frac{1}{2}$	1 $\frac{1}{2}$	—	1 $\frac{1}{2}$	Flat	1 $\frac{1}{2}$	29	#	
SAP3	$\frac{1}{2}$	110	1740	17.35	5 $\frac{1}{4}$	4 $\frac{3}{8}$	6 $\frac{5}{8}$	6 $\frac{1}{2}$	6 $\frac{1}{2}$	3 $\frac{1}{2}$	$\frac{1}{2}$	$\frac{1}{2}$	1 $\frac{1}{2}$	—	1 $\frac{1}{2}$	Flat	1 $\frac{1}{2}$	28	#	
SAB3S	$\frac{1}{2}$	110	1740	25.75	5 $\frac{1}{4}$	4 $\frac{3}{8}$	6 $\frac{5}{8}$	6 $\frac{1}{2}$	6 $\frac{1}{2}$	3 $\frac{1}{2}$	$\frac{1}{2}$	$\frac{1}{2}$	1 $\frac{1}{2}$	—	1 $\frac{1}{2}$	Flat	1 $\frac{1}{2}$	40	#	
SAB5	$\frac{3}{4}$	110	1740	24.60	5 $\frac{1}{4}$	5 $\frac{1}{8}$	6 $\frac{5}{8}$	8	6 $\frac{1}{2}$	3 $\frac{1}{2}$	$\frac{1}{2}$	$\frac{1}{2}$	1 $\frac{1}{2}$	—	1 $\frac{1}{2}$	Flat	1 $\frac{1}{2}$	40	#	

THREE-PHASE MOTORS (60 CYCLES)

PAB3	$\frac{1}{2}$	220	1740	28.95	5 $\frac{1}{4}$	4 $\frac{3}{8}$	6 $\frac{5}{8}$	7 $\frac{1}{4}$	6 $\frac{1}{2}$	3 $\frac{1}{2}$	$\frac{1}{2}$	$\frac{1}{2}$	1 $\frac{1}{2}$	2	1 $\frac{1}{2}$	$\frac{3}{8}$ "	$\frac{1}{2}$ "	1 $\frac{1}{2}$	28	#
PEB3	$\frac{3}{8}$	220	3450	31.20	5 $\frac{1}{4}$	4 $\frac{3}{8}$	6 $\frac{5}{8}$	7 $\frac{1}{4}$	6 $\frac{1}{2}$	3 $\frac{1}{2}$	$\frac{1}{2}$	$\frac{1}{2}$	1 $\frac{1}{2}$	2	1 $\frac{1}{2}$	$\frac{3}{8}$ "	$\frac{1}{2}$ "	1 $\frac{1}{2}$	28	#
POB3	$\frac{3}{8}$	220	1140	31.20	5 $\frac{1}{4}$	4 $\frac{3}{8}$	6 $\frac{5}{8}$	7 $\frac{1}{4}$	6 $\frac{1}{2}$	3 $\frac{1}{2}$	$\frac{1}{2}$	$\frac{1}{2}$	1 $\frac{1}{2}$	2	1 $\frac{1}{2}$	$\frac{3}{8}$ "	$\frac{1}{2}$ "	1 $\frac{1}{2}$	28	#
PAB5	$\frac{1}{2}$	220	1740	34.10	5 $\frac{1}{4}$	5 $\frac{1}{8}$	6 $\frac{5}{8}$	8	6 $\frac{1}{2}$	3 $\frac{1}{2}$	$\frac{1}{2}$	$\frac{1}{2}$	1 $\frac{1}{2}$	2	1 $\frac{1}{2}$	$\frac{3}{8}$ "	$\frac{1}{2}$ "	1 $\frac{1}{2}$	40	#
PEB5	$\frac{3}{8}$	220	3450	37.00	5 $\frac{1}{4}$	5 $\frac{1}{8}$	6 $\frac{5}{8}$	8	6 $\frac{1}{2}$	3 $\frac{1}{2}$	$\frac{1}{2}$	$\frac{1}{2}$	1 $\frac{1}{2}$	2	1 $\frac{1}{2}$	$\frac{3}{8}$ "	$\frac{1}{2}$ "	1 $\frac{1}{2}$	40	#
POB5	$\frac{3}{8}$	220	1140	37.00	5 $\frac{1}{4}$	5 $\frac{1}{8}$	6 $\frac{5}{8}$	8	6 $\frac{1}{2}$	3 $\frac{1}{2}$	$\frac{1}{2}$	$\frac{1}{2}$	1 $\frac{1}{2}$	2	1 $\frac{1}{2}$	$\frac{3}{8}$ "	$\frac{1}{2}$ "	1 $\frac{1}{2}$	40	#
PAB7	$\frac{3}{4}$	220	1740	43.50	5 $\frac{1}{4}$	5 $\frac{1}{8}$	6 $\frac{5}{8}$	8 $\frac{1}{2}$	6 $\frac{1}{2}$	3 $\frac{1}{2}$	$\frac{1}{2}$	$\frac{1}{2}$	1 $\frac{1}{2}$	2	1 $\frac{1}{2}$	$\frac{3}{8}$ "	$\frac{1}{2}$ "	1 $\frac{1}{2}$	62	#
PEB7	$\frac{3}{4}$	220	3450	44.95	5 $\frac{1}{4}$	5 $\frac{1}{8}$	6 $\frac{5}{8}$	8 $\frac{1}{2}$	6 $\frac{1}{2}$	3 $\frac{1}{2}$	$\frac{1}{2}$	$\frac{1}{2}$	1 $\frac{1}{2}$	2	1 $\frac{1}{2}$	$\frac{3}{8}$ "	$\frac{1}{2}$ "	1 $\frac{1}{2}$	44	#
PIB7	$\frac{3}{4}$	220	865	79.75	7 $\frac{3}{8}$	4 $\frac{3}{8}$	8 $\frac{1}{2}$	9	8 $\frac{1}{2}$	4 $\frac{1}{2}$	$\frac{1}{2}$	$\frac{1}{2}$	2 $\frac{1}{2}$	2 $\frac{1}{2}$	1 $\frac{1}{2}$	$\frac{3}{8}$ "	$\frac{1}{2}$ "	1 $\frac{1}{2}$	76	#
POB7	$\frac{3}{4}$	220	1140	68.90	7 $\frac{3}{8}$	4 $\frac{3}{8}$	8 $\frac{1}{2}$	9	8 $\frac{1}{2}$	4 $\frac{1}{2}$	$\frac{1}{2}$	$\frac{1}{2}$	2 $\frac{1}{2}$	2 $\frac{1}{2}$	1 $\frac{1}{2}$	$\frac{3}{8}$ "	$\frac{1}{2}$ "	1 $\frac{1}{2}$	62	#
PEB10	1	220	3450	58.00	7 $\frac{3}{8}$	4 $\frac{3}{8}$	8 $\frac{1}{2}$	9 $\frac{1}{2}$	8 $\frac{1}{2}$	4 $\frac{1}{2}$	$\frac{1}{2}$	$\frac{1}{2}$	2 $\frac{1}{2}$	2 $\frac{1}{2}$	1 $\frac{1}{2}$	$\frac{3}{8}$ "	$\frac{1}{2}$ "	1 $\frac{1}{2}$	62	#
PAB10	1	220	1750	59.45	7 $\frac{3}{8}$	4 $\frac{3}{8}$	8 $\frac{1}{2}$	9	8 $\frac{1}{2}$	4 $\frac{1}{2}$	$\frac{1}{2}$	$\frac{1}{2}$	2 $\frac{1}{2}$	2 $\frac{1}{2}$	1 $\frac{1}{2}$	$\frac{3}{8}$ "	$\frac{1}{2}$ "	1 $\frac{1}{2}$	76	#
PEB15	$\frac{1}{2}$	220	3450	75.35	7 $\frac{3}{8}$	4 $\frac{3}{8}$	8 $\frac{1}{2}$	9 $\frac{1}{2}$	8 $\frac{1}{2}$	4 $\frac{1}{2}$	$\frac{1}{2}$	$\frac{1}{2}$	2 $\frac{1}{2}$	2 $\frac{1}{2}$	1 $\frac{1}{2}$	$\frac{3}{8}$ "	$\frac{1}{2}$ "	1 $\frac{1}{2}$	76	#
PEB30	3	220	3450	100.05	8	6 $\frac{1}{2}$	8	14 $\frac{1}{2}$	8 $\frac{1}{2}$	4 $\frac{1}{2}$	$\frac{1}{2}$	$\frac{1}{2}$	2 $\frac{1}{2}$	2 $\frac{1}{2}$	1 $\frac{1}{2}$	$\frac{3}{8}$ "	$\frac{1}{2}$ "	1 $\frac{1}{2}$	95	#

CAPACITOR START MOTORS (60 CYCLES, SINGLE PHASE) L = 1 $\frac{3}{4}$ "

KAB4	$\frac{1}{4}$	110-220	1740	22.10	5 $\frac{1}{4}$	4 $\frac{3}{8}$	6 $\frac{5}{8}$	6	6 $\frac{1}{2}$	3 $\frac{1}{2}$	$\frac{1}{2}$	$\frac{1}{2}$	1 $\frac{1}{2}$	1 $\frac{1}{2}$	—	$\frac{1}{4}$ "	Flat	1 $\frac{1}{2}$	28	#
KAB3	$\frac{1}{4}$	110-220	1740	26.85	5 $\frac{1}{4}$	4 $\frac{3}{8}$	6 $\frac{5}{8}$	7 $\frac{1}{4}$	6 $\frac{1}{2}$	3 $\frac{1}{2}$	$\frac{1}{2}$	$\frac{1}{2}$	1 $\frac{1}{2}$	2	—	$\frac{1}{4}$ "	Flat	1 $\frac{1}{2}$	29	#
KEB3	$\frac{1}{2}$	110-220	3450	28.30	5 $\frac{1}{4}$	4 $\frac{3}{8}$	6 $\frac{5}{8}$	7 $\frac{1}{4}$	6 $\frac{1}{2}$	3 $\frac{1}{2}$	$\frac{1}{2}$	$\frac{1}{2}$	1 $\frac{1}{2}$	2	—	$\frac{1}{4}$ "	Flat	1 $\frac{1}{2}$	30	#
KAB5	$\frac{1}{2}$	110-220	3450	34.10	5 $\frac{1}{4}$	5 $\frac{1}{8}$	6 $\frac{5}{8}$	8	6 $\frac{1}{2}$	3 $\frac{1}{2}$	$\frac{1}{2}$	$\frac{1}{2}$	1 $\frac{1}{2}$	2	1 $\frac{1}{2}$	$\frac{3}{8}$ "	$\frac{1}{2}$ "	1 $\frac{1}{2}$	40	#
KAB5-S	$\frac{1}{2}$	110-220	1740	35.55	5 $\frac{1}{4}$	5 $\frac{1}{8}$	6 $\frac{5}{8}$	8	6 $\frac{1}{2}$	3 $\frac{1}{2}$	$\frac{1}{2}$	$\frac{1}{2}$	1 $\frac{1}{2}$	2	1 $\frac{1}{2}$	$\frac{3}{8}$ "	$\frac{1}{2}$ "	1 $\frac{1}{2}$	40	#
KAB5	$\frac{3}{8}$	110-220	1740	34.10	5 $\frac{1}{4}$	5 $\frac{1}{8}$	6 $\frac{5}{8}$	8	6 $\frac{1}{2}$	3 $\frac{1}{2}$	$\frac{1}{2}$	$\frac{1}{2}$	1 $\frac{1}{2}$	2	1 $\frac{1}{2}$	$\frac{3}{8}$ "	$\frac{1}{2}$ "	1 $\frac{1}{2}$	40	#
KEB7	$\frac{3}{8}$	110-220	3450	47.15	5 $\frac{1}{4}$	5 $\frac{1}{8}$	6 $\frac{5}{8}$	8 $\frac{1}{2}$	6 $\frac{1}{2}$	3 $\frac{1}{2}$	$\frac{1}{2}$	$\frac{1}{2}$	1 $\frac{1}{2}$	2	1 $\frac{1}{2}$	$\frac{3}{8}$ "	$\frac{1}{2}$ "	1 $\frac{1}{2}$	41	#
KEB10	1	110-220	3450	61.65	5 $\frac{1}{4}$	5 $\frac{1}{8}$	6 $\frac{5}{8}$	8 $\frac{1}{2}$	6 $\frac{1}{2}$	3 $\frac{1}{2}$	$\frac{1}{2}$	$\frac{1}{2}$	1 $\frac{1}{2}$	2	1 $\frac{1}{2}$	$\frac{3}{8}$ "	$\frac{1}{2}$ "	1 $\frac{1}{2}$	62	#
KEB20	2	220	3450	102.95	8	6 $\frac{1}{2}$	8	14 $\frac{1}{2}$	8 $\frac{1}{2}$	4 $\frac{1}{2}$	$\frac{1}{2}$	$\frac{1}{2}$	2 $\frac{1}{2}$	2 $\frac{1}{2}$	1 $\frac{1}{2}$	$\frac{3}{8}$ "	$\frac{1}{2}$ "	1 $\frac{1}{2}$	95	#

DIRECT CURRENT MOTORS

DAB3	$\frac{1}{2}$	115	1740	37.70	5 $\frac{1}{4}$	3 $\frac{3}{8}$	6 $\frac{1}{2}$	6 $\frac{3}{4}$	7	3 $\frac{3}{8}$	$\frac{1}{2}$	$\frac{1}{2}$	1 $\frac{1}{2}$	1 $\frac{1}{2}$	—	$\frac{1}{4}$ "	Flat	1"	32	#
PAB5	$\frac{3}{8}$	115	3450	37.70	5 $\frac{1}{4}$	3 $\frac{3}{8}$	6 $\frac{1}{2}$	6 $\frac{3}{4}$	7	3 $\frac{3}{8}$	$\frac{1}{2}$	$\frac{1}{2}$	1 $\frac{1}{2}$	1 $\frac{1}{2}$	—	$\frac{1}{4}$ "	Flat	1"	35	#
DEB7	$\frac{3}{8}$	115	3450	60.20	6 $\frac{1}{4}$	5 $\frac{1}{2}$	8	8 $\frac{1}{2}$	8	4 $\frac{1}{4}$	$\frac{3}{8}$	$\frac{3}{8}$	2 $\frac{1}{2}$	2 $\frac{1}{2}$	1 $\frac{1}{4}$	$\frac{3}{8}$ "	$\frac{1}{2}$ "	1 $\frac{1}{2}$	81	#

REPULSION INDUCTION MOTORS (60 CYCLES, SINGLE PHASE)

RAB3	$\frac{1}{2}$	110-220	1750	28.95	5 $\frac{1}{4}$	4 $\frac{1}{2}$	7 $\frac{3}{8}$	10 $\frac{1}{2}$	7 $\frac{3}{8}$	3 $\frac{1}{2}$	$\frac{5}{8}$	$\frac{5}{8}$	1 $\frac{1}{2}$	1 $\frac{1}{2}$	1 $\frac{1}{2}$	$\frac{3}{8}$ "	$\frac{1}{2}$ "	1 $\frac{1}{2}$	50	#
RAB5-R	$\frac{1}{2}$	110-220	1750	48.75	5 $\frac{1}{4}$	4 $\frac{1}{2}$	7 $\frac{3}{8}$	10 $\frac{1}{2}$	8 $\frac{1}{2}$	3 $\frac{1}{2}$	$\frac{5}{8}$	$\frac{5}{8}$	2 $\frac{1}{2}$	2 $\frac{1}{2}$	1 $\frac{1}{2}$	$\frac{3}{8}$ "	$\frac{1}{2}$ "	1 $\frac{1}{2}$	60	#
RAB7-R	$\frac{1}{2}$	110-220	1750	63.95	7 $\frac{1}{2}$	4 $\frac{1}{2}$	8 $\frac{3}{8}$	11 $\frac{1}{2}$	8 $\frac{1}{2}$	4 $\frac{1}{2}$	$\frac{5}{8}$	$\frac{5}{8}$	2 $\frac{1}{2}$	2 $\frac{1}{2}$	1 $\frac{1}{2}$	$\frac{3}{8}$ "	$\frac{1}{2}$ "	2"	75	#
RAB10	1	110-220	1750	65.25	7 $\frac{1}{2}$	4 $\frac{1}{2}$	8 $\frac{3}{8}$	11 $\frac{1}{2}$	9	4 $\frac{1}{2}$	$\frac{5}{8}$	$\frac{5}{8}$	2 $\frac{1}{2}$	2 $\frac{1}{2}$	1 $\frac{1}{2}$	$\frac{3}{$				

MOTOR GRINDERS

- All grinders have extended end bells except the ¼ Horse Power model, KG4
- Motors are totally enclosed with special shaft seals to prevent abrasive dust damaging vital parts
- A ground wire is furnished on all models except the three phase
- Precision, dust sealed ball bearings are standard equipment on all models
- The guards are easily removed for buffing operations
- All models fit the pedestal base, GMP5, which is adjustable for height
- Operating speed of all standard models is 3450 R.P.M.

½ H.P. CAPACITOR TYPE GRINDER

This grinder GR50 with its capacitor type motor and ample overload capacity will deliver years of steady, consistent service. The wheels are 7" in diameter, 1" wide, 3/8" hole. Full protection guards designed according to latest safety code requirements; large, non-shatterable glass shields; adjustable tool rests and cooling cup. A highgrade snap switch is built into the base.

COMBINATION GRINDER AND DISC SANDER

This combination model CG50 has the same features as specified above for the GR50 except that the disc sander attachment is substituted for one wheel and guard. CG50 will prove an invaluable aid in any shop where there are small parts to be ground and surfaced . . . a workman can do several different operations on a single piece without leaving the machine.

PEDESTAL STAND FOR ALL MODELS

The table to which this grinder is attached, and the tripod stand, are made of cast iron. The table is 18" x 14" with a cooling cup located at the front center. A liberal sized tool tray is provided on either side of the cooling cup. The top of the table is drilled to take all current model grinders. A ground steel column, 2" in diameter, connects the table with the stand and affords adjustments for height with a variation of 12". The stand has three legs providing unusual stability. See listing below of GMP5.



GR50	½ H.P. Grinder (110 volts, 60 cycle, A.C.) as shown above (without stand).....	\$61.65
	50 cycle, 110 volts, \$1.10 extra. 220 to 250 volts, 60 cycle, \$4.35 extra. 3 phase, 200 volts, 60 cycles, no extra cost (but switch is not supplied). 3 phase 220 volts, 50 cycle, \$5.80 extra. Direct current, 115, 230, or 250 volts, \$21.75 extra. (Switch not supplied with 3 phase motors.) Shipping weight 80 lbs.	
CG50	Combination Grinder and Disc Sander as shown in insert	71.80
GMP5	Pedestal Stand including table. Shipping weight 70 lbs.	18.15
GR36	⅓ H.P. Grinder (110 volts, 60 cycle, A.C.) as shown. Shipping weight 60 lbs.	39.90
GR35	⅓ H.P. Grinder (same as GR36 but including eye shields and cooling cup)	43.50
	50 cycle, 110 volts, \$1.10 extra. 220 to 250 volts, 60 cycle, \$2.90 extra. 3 phase, 220 volts, 60 cycle, \$8.70 extra. 3 phase, 220 volts, 50 cycle, \$13.05 extra. D.C. 115, 230 or 250 volts, \$17.40 extra. No switch on 3 phase motors.	
KG4	¼ H.P. Grinder (110 volts, 50-60 cycles, A.C.), as shown. Shipping weight approx. 50 lbs.	26.85
	220-230 volts \$2.90 extra. Not available for direct current or other cycles.	
	½, ¼, ⅓ H.P. GRINDERS WITH STEEL GUARDS AVAILABLE ON SPECIAL ORDER AT \$6.55 EXTRA.	



KG4

⅓ H.P. GRINDER (right)

This GR36 grinder has tool rests adjustable two ways, guards which have covers on the outside of the wheels, a sturdy 10 ampere switch located in the base. Wheels are 6" in diameter, ¾" wide, ½" hole. A 10' cord and plug is supplied.



GR36

¼ H.P. GRINDER (left)

Wheels are 6" in diameter, ½" wide, ½" hole. Tool rests are adjustable for wheel wear. On and off switch, cord and plug supplied.

WALKER-TURNER DEPENDABILITY

TRANSMISSION EQUIPMENT

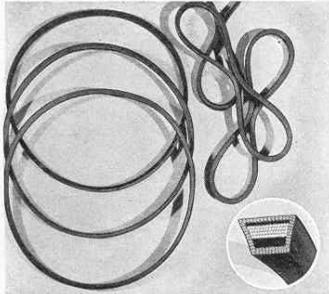
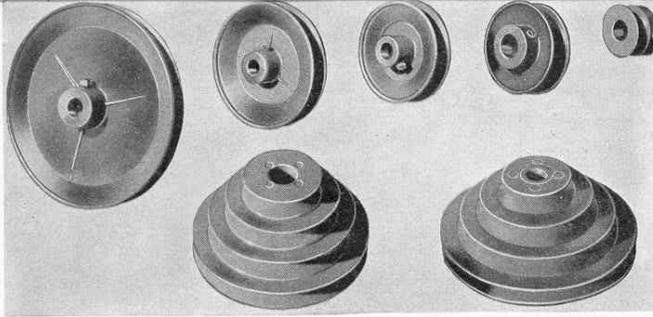

V-BELT LISTING

VB20—20".....	\$.80	VB44—44".....	\$1.15
VB24—24".....	.80	VB48—48".....	1.15
VB26—26".....	.95	VB54—54".....	1.30
VB29—29".....	.95	VB58—58".....	1.30
VB32—32".....	.95	VB62—62".....	1.55
VB34—34".....	.95	VB66—66".....	1.55
VB36—36".....	.95	VB86—86".....	1.90
VB39—39".....	.95	VB92—92".....	2.90
VB42—42".....	1.15		
3VB16—Troxpe Belts			
Set of three matched.....			\$3.25

	No.	No. of Grooves	Size of Steps	Price			
1/2"	PV175	1	1 3/4"	\$.50			
	PV25	1	2 3/2"	.50			
	PV350	1	3 3/2"	.80			
	PV450	1	4 "	.65			
	PV65	1	6 1/2"	1.40			
	PV30	3	3 1/4"	2 1/2"	1 1/4"	.80	
	PV34	4	1 3/4"	1 3/4"	1 3/4"	.90	
	PV41	4	3 3/4"	2 3/4"	1 3/4"	.90	
	PV43	4	4 3/4"	3 3/4"	1 3/4"	1.40	
	PV4	4	3 1/4"	2 1/2"	1 3/4"	.90	
5/8"	PV550	4	5 "	3 7/8"	1 3/4"	1.40	
	PV500	4	5 1/2"	4 3/4"	3 3/8"	2 3/4"	1.75
	PV158	1	1 3/4"			.50	
	PV258	1	2 3/2"			.50	
3/4"	PV365	1	3 "		.65		
	PV458	1	4 "		.65		
	PV58	1	6 1/2"		1.40		
	PV35	3	3 1/4"	2 1/2"	1 1/4"	.80	
	PV45	4	3 1/4"	2 3/4"	1 3/4"	.90	
	PV48	4	4 3/4"	4 1/4"	3 3/4"	1.40	
	PV625	4	4 "	3 3/4"	2 3/4"	.90	
	PV58	4	5 "	3 7/8"	1 3/4"	1.40	
	PV62	4	5 1/2"	4 3/4"	3 3/8"	2 3/4"	1.75
	1"	PV275	1	2 1/2"		.50	
PV375		1	3 "		.50		
PV475		1	4 "		.65		
BN18		1	6 1/2"		1.40		
PV37		3	3 3/4"	2 3/4"	1 3/4"	.80	
PV47		4	4 3/4"	4 1/4"	3 3/4"	.90	
PV49		4	4 3/4"	4 1/4"	3 3/4"	1.40	
PV40		4	4 "	3 3/4"	2 3/4"	1 3/4"	.90
PV575		5	5 1/2"	3 3/4"	2 3/4"	1.40	
PV750		4	5 3/2"	4 3/4"	3 3/8"	2 3/4"	1.75

WIDE SELECTION OF PULLEYS

DRIVER pulleys are available in various diameters and bores to fit practically every need. Each pulley has two set screws for maximum holding power. Pitch of all pulley grooves is 43°. Best results will be obtained by using DRIVER belts and pulleys exclusively.

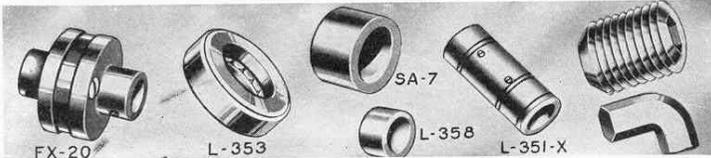

All of the transmission parts are for light shafting. With them a drive for light machinery can be set up very inexpensively.

FX20 Flexible coupling (for 1/2" shafting).....	\$.50
L351X Rigid coupling (for 1/2" shafting).....	\$.50
L351 1/2"x24" Ground steel shaft.....	.50
COM. 1/4" Hollow-head set screws, ea.	\$.10

COM. Wrench for above.....	\$.10
COM. 1/8" Hollow-head set screws, ea.	.10
COM. Wrench for above.....	.10
L358 1/2" Shaft collar.....	.15
C58 3/8" Shaft collar.....	.20
SA7 3/4" Shaft collar.....	.50
L353 1/2" Ball thrust bearing.....	.50
58 3/8" Ball thrust bearing.....	.65
75 1/2" Ball thrust bearing.....	.90

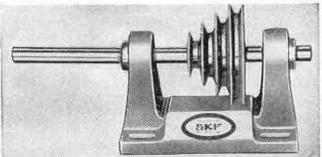

JACKSHAFT ASSEMBLY

This unit can be used for increasing or reducing machine speeds. The shaft turns on precision ball-bearings. Base holes are located identically with most W.T. motor mountings. Four variations of speeds are provided.

MD18 Jackshaft assembly as shown.....\$7.60

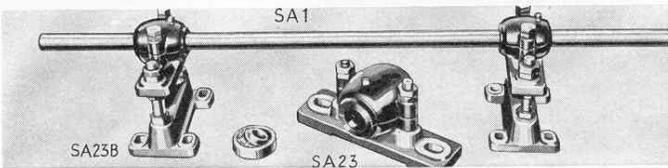

SELF-ALIGNING BALL-BEARING HANGERS

Friction or binding due to faulty shaft alignment is eliminated with these hangers which absorb considerable misalignment by their self-aligning feature. These bearings will more than repay the difference in cost over

cheap habit or sleeve bearings through their savings in power and attention.

SA23B 3/4" Hanger (with base).....	\$6.75
SA23 3/4" Pillow block only.....	5.15
SA78 3/8" Pillow block only.....	7.20
SA1 3/4" x 48" Ground steel shaft	1.95

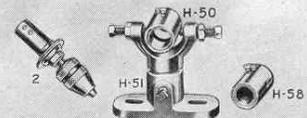

SHAFT HANGERS • WORK ARBOR No. 2 Motor Work Arbor (with 1/2" 3 jaw chuck)

.....	\$1.60
H51 Hanger only (less bearing).....	1.15
H50 1/2" Bronze bushed bearing for H51	.45
H58 3/8" Bronze bushed bearing for H51	.50
H75 3/4" Bronze bushed bearing for H51	.60

FOR THE INDUSTRIAL OR HOME SHOP

4" AND 6" BENCH GRINDERS

6" BALL BEARING MODEL

This grinder, with grease-sealed ball bearings and sturdy spindle is built to precision standards and will retain its precision indefinitely. The bearings are fully protected from abrasive dust and dirt by dust caps. Tool rests are properly located, accurately fitted and fully adjustable. Guards are close-fitting. Large flanges hold the wheels securely from both sides.

Thousands of these grinders are giving excellent service in industrial plants, service stations and home workshops. Besides grinding, this grinder can be used for several other operations. Wire scratch wheels or cloth buffing wheels can be attached to the spindle ends, in place of the grinding wheels, and used for cleaning, polishing and buffing metal. The right wheel, guard and tool rest can quickly be removed and replaced by the sanding table and disc, forming an excellent, inexpensive disc-sanding machine.

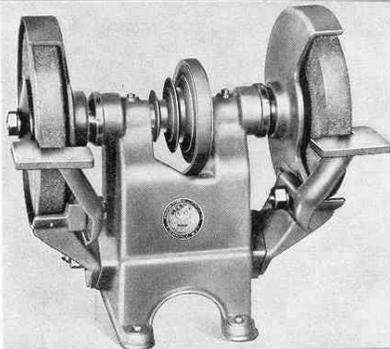

BG25 6" Ball-bearing Bench Grinder, complete with belt and motor pulley **\$15.60**

BG30 Same as BG25 but without wheels, guards, and tool rests. **10.50**

BG31 Sanding Attachments, consisting of abrasive disc, tilting table, mitre gauge, and attaching bolt **9.10**



SPECIFICATIONS

GRINDING WHEELS: Excellent quality, 6" diameter, 3/8" wide, 1/2" bore.
SPINDLE: 1/2" at both ends to take standard accessories. May be driven from behind or above.
HEIGHT: Overall 10 1/2".
LENGTH: Overall 11".
SHIPPING WEIGHT: 23 lbs.

Regular equipment includes 3 speed V motor pulley and 42" endless V belt. This grinder may be set up easily as a disc sander as shown above.

Handiest of all small tools for the shop or home, these two new grinders are priced amazingly low for the value that is built into them. Both have sturdy cast-iron frames, heavy steel spindles and high quality wheels. They are unusually smooth and quiet in operation.

6" BENCH GRINDER

The frame of this grinder is heavy, close-grained cast-iron carefully machined. It encloses the drive pulley for full protection. Wheels are aluminous oxide, 6" in diameter, 1/2" in width and have 1/2" bores. One is 60 grit and the other 36 grit. The spindle is 3/8" in diameter at the bearings, 1/2" at ends. Bearings are bronze with grease cups located above them. Tool rests are cast-iron adjustable for wheel wear. Wheel guards are cast-iron fully adjustable. A single groove V pulley, 1 3/4" in diameter is supplied on the spindle. Speeds up to 2500 R.P.M. Height over all 9". Width 8 1/4". Weight 19 lbs.

PG10A 6" Bench Grinder, as shown..... **\$8.70**
PG10 As above, less wheels..... **6.55**

4" BENCH GRINDER

This grinder is an exceptional value. The frame is close-grained cast-iron carefully machined. It encloses the drive pulley for extra protection. Wheels are aluminous oxide, 4" in diameter, 3/4" in width and have 1/2" bores. One is 60 grit and the other 36. The spindle is 5/8" in diameter at the bearings and 1/2" at the ends. Bearings are the plain type lubricated through spring cap oil cups. Tool rests are adjustable for wheel wear. A single groove V pulley 1 3/4" in diameter is supplied on the spindle. Recommended speeds, up to 1750 R.P.M. Height overall 6", width 7 3/4", weight 9 lbs.

SG5 4" Bench Grinder, as shown..... **\$4.00**

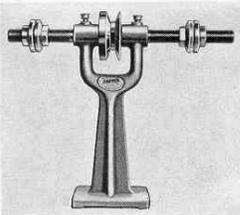

POLISHING HEAD

With its numerous accessories, the polishing head is handy for sharpening tools, removing rust and paint, grinding and polishing metals, and drilling. A wide selection of grinding wheels, cloth buffing and wire scratch wheels, and 1/4" chuck are available.

The polishing head provides an excellent permanent setup for grinding wheels which are used so frequently in sharpening edged tools, garden implements and dozens of items in the home. Spindle is 1/2" in diameter.

94A Polishing Head, as shown
\$1.30

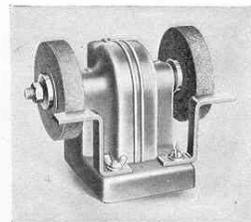
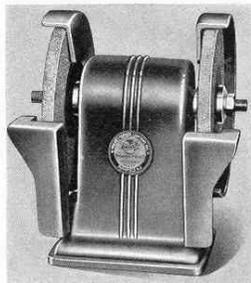

BUILT TO PRECISION STANDARDS

NEW SEMI-

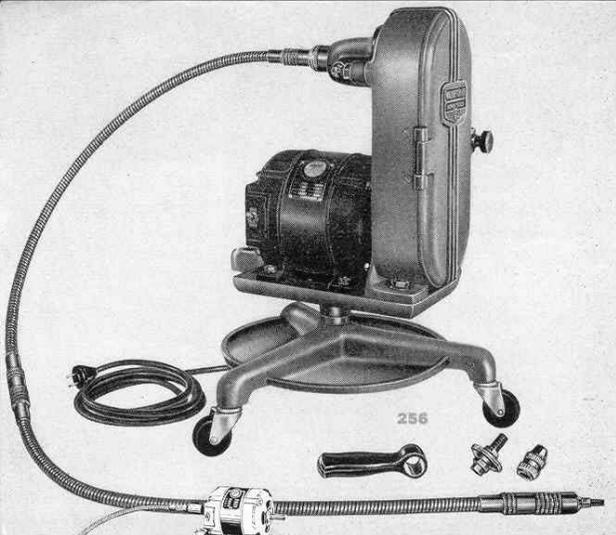

following pages many thousands are in use on light and medium duty work in industrial and commercial plants, and in home workshops. Their fine record of performance has been established for many years. We believe them to be the best available at their prices and superior to many other shafts selling at higher prices.

The outfits above 256 and at left 257 are the same except that the upper one has a wide selection of speeds while the lower one operates at motor speeds only. Although these shafts are not as heavy as those shown on the

SHAFT ASSEMBLY

This assembly, comprising a $\frac{1}{2}$ " diameter core, casing, ball bearing motor coupling, adapter and cup- and cone-type ball bearing handpiece is ready to attach to any motor shaft of $\frac{1}{2}$ " diameter turning at not less than 1740 R.P.M. The adapter with flanges is $\frac{1}{2}$ " in diameter. Same core, casing, handpiece and adapter as used in outfit number 256. Length of assembly, 49 $\frac{1}{2}$ ".

5340 Shaft assembly as shown\$6.60

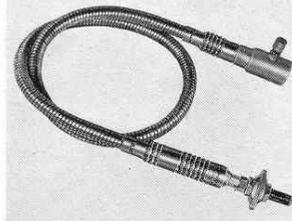

GENERAL FLEXIBLE SHAFT ACCESSORIES

BBF7 Motor coupling\$1.70
 SL5 Lubricant50
 939 0" to 1/4" Drill Chuck.....50
 DP110 1/2" Drill Chuck.....1.15
 FS413 8" Sanding disc (1/2" hole)1.15
 FS409 Carbon Removing Brush1.25

FS426 6" Cloth buffer (1/2" hole)\$.90
 931 3" Cloth buffer (1/2" hole)50
 BBF5 Hand Grip for Shaft.....45
 BBF6 Wheel guard90
 FS425 Sheepskin polisher.....1.70
 L355 6 abrasive discs.....60

- Heavy cast-iron housing carries the jackshaft bearing assembly, encloses belt and pulleys
- Upper section swivels on tripod base
- Jackshaft turns on two large, dust-sealed precision ball bearings
- Cores are built up of transversely wound layers of high carbon steel wire designed for maximum strength and flexibility
- Casings of 256, 257 and 5340 are 43" long, made of interlocking layers of steel. Inner layer is carbon steel oil tempered. Protected against grease leakage.
- Four speeds cover all normal requirements
- Handpiece is ball-bearing, cup-and-cone type, intended for semi-industrial use

The flexible shaft has won its present important position in the home, shop and industrial plant by filling a definite need simply and economically. Through the flexible shaft, power is transmitted at various speeds with the continuity and properties of a solid shaft, yet it can be turned around corners and operated at all angles.

256	Multi-speed portable flexible shaft machine as shown, less motor.....	\$27.80
SAB3X	1/3 H.P., A.C. motor.....	20.25
256	Consists of:	
BF52	Base with motor table.....	6.60
SF52A	Pulley housing, ball bearing jackshafts, pulleys and belt.....	12.50
BBF1	Ball bearing handpiece.....	1.55
BBF2L	43 1/4" casing, 2 supplied, each.....	1.55
BBF3L	43 3/8" core, 2 supplied, each.....	1.55
BBF5	Grip for shaft.....	.45
FS405	Adapter.....	.45
939	1/4" drill chuck.....	50
257	Direct drive, portable, flexible shaft model shown (same as 256 but without SF52A), includes BBF7 coupling.....	16.60

Because of differences in the bearing unit and ferrules the shafts used on 256, 257 and 5340 are not interchangeable with the shafts listed on pages 46 and 47.

OTHER ACCESSORIES

A wide selection of grinding wheels, sanding drums, shaping, routing and carving cutters, wire scratch wheels, and cloth buffing wheels are shown on pages 8, 23 and 31.

FOR ALL MODELS

High quality, accurately formed aluminum oxide stones with 1/8" round shanks.

Grinding shapes, each (C, D, E, G, K, L).....\$1.55
 I Grinding shape.....1.90

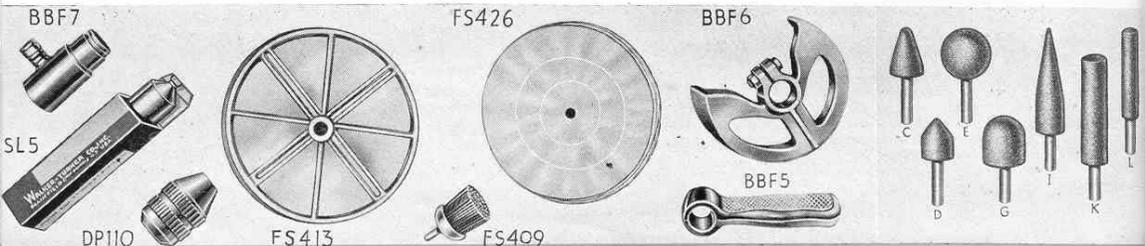

WALKER-TURNER FLEX. SHAFTS ENABLE

INDUSTRIAL FLEXIBLE SHAFTS

The 253 model has the same tripod base and motor table as the 256 but uses a much heavier shaft assembly attached directly to the motor shaft with an SKF ball-bearing motor coupling. The core, casing, motor coupling and handpiece are all larger than those used on the 256 model. This outfit is for commercial and semi-industrial work. Sanding, grinding, buffing and polishing, paint and rust removing, drilling and almost countless other jobs are done—easily and effectively—with the flexible shaft. This tool, with the necessary accessories, works in places inaccessible to other tools. It is at all times readily portable—a veritable workshop in itself!

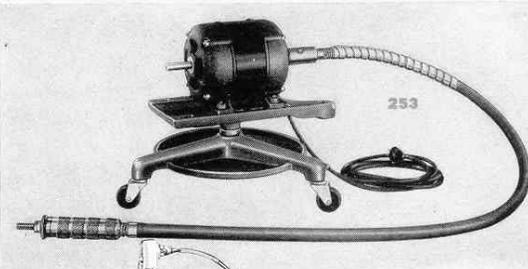

- 253** Direct drive portable flexible shaft machine as shown, less motor includes motor coupling SF57..... **\$26.25**
KEB5X ½ H.P. A.C., 110-220 volts, 60 cycles, 3450 R.P.M. motor..... **34.10**
258 Multi-speed model as shown, including SF52A pulley housing ball bearing jackshaft, pulleys and belt; less motor and SF57 coupling. Uses KEB5X motor..... **34.95**
 SF Model Shafts shown on pages 46 and 47 will not fit 253 or 258.

258

The above shaft, 253, and that at left, 258, are ideally adapted for all-round work on operations too heavy for the lighter shafts shown on the opposite page. They are not intended to replace

the heavy industrial models, shown on next page, for heavy production work. The two models are identical excepting that one is multi-speed while the other is direct—connected to the motor. The core is 6' long and ¾" in diameter.

Repair, service and maintenance shops of all kinds will find one of these outfits indispensable for grinding, sanding, drilling, buffing and similar operations.

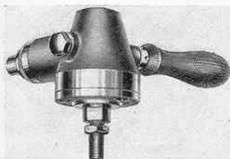

ANGLE HEAD

The angle head permits mounting accessories at right angles to the shaft. It is essential when low speed is required as it provides slow tool speeds without diminishing the speed of the flexible shaft core. Spiral gears reduce speed in ratio of three to two.

- 249** Angle Head, fits 256, 257, 253, 258 and 5340. **\$20.65**



FLOOR WAXING

A waxing brush simplifies what otherwise is a tedious operation. It is used effectively for waxing floors, wall panels, fixtures and furniture. Wire cup brushes and scratch wheels are helpful in removing rust and paint.

- FS417** Waxing Brush..... **\$1.30**

SHAFT ASSEMBLY

This is the same core, casing, motor coupling and handpiece used on the model above. It fits any ½" shaft.

- 251** Shaft assembly, complete with core, casing, handpiece and motor coupling..... **\$18.70**
SF552 Replacement core for 251, 253, 258..... **6.20**

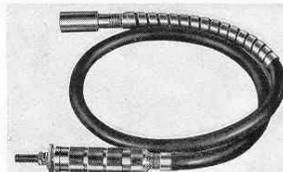

SKF HANDPIECE (Used on 253, 258. Fits 256, 257)

This ball-bearing handpiece is larger, heavier and more substantial than the BBF1 handpiece. Does not have interchangeable arbors like those on next page.

- SF506** As shown..... **\$5.65**

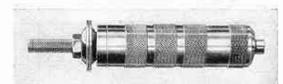

CARVING BURRS AND CUTTERS FOR ALL MODELS

- | | |
|--|--|
| CR1 Liner..... \$2.75 | CR6 Straight Face..... \$2.75 |
| CR2 Half Round..... 2.75 | CR7 Extension Shank for holding above cutters..... .80 |
| CR3 Round Nose..... 2.75 | CR8 Saw..... .95 |
| CR4 Hook Tool..... 2.75 | CR9 Round..... .95 |
| CR5 Button Drill..... 2.75 | |

- | |
|---|
| CR10 Flame..... \$.95 |
| CR11 Inverted Cone..... .95 |
| CR12 Pointed..... .95 |
| CR13 Cylindrical..... .95 |
| CR20 Set of 6 Burrs (1/8" shanks)..... 5.60 |

SKF MOTOR COUPLING

Larger and more durable than the BBF7 coupling used on 5340, this coupling is built to last indefinitely on heavy production work. Two precision ball-bearings carry the load.

- SF57** SKF motor coupling..... **\$4.95**

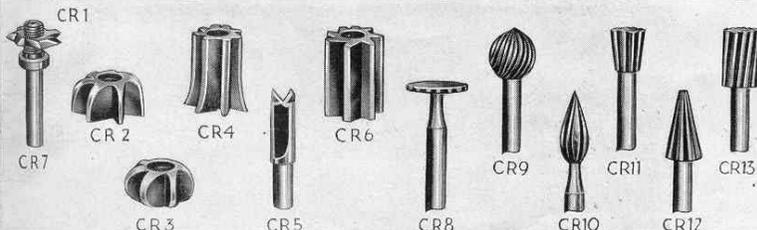

YOU TO TAKE THE TOOL TO THE WORK

INDUSTRIAL

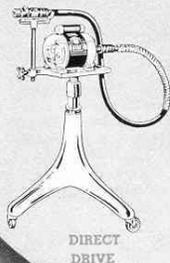

- Models for industrial and commercial needs
- High speed models for tool and die making
- Slower speed types for automotive body work
- Heavier models for foundry grinding and snagging
- Wide selection of cores, casings, handpieces, motors and a choice of single speed or multi-speed drives
- Proper shaft and motor for your use should be selected from those listed on next page
- High models have telescoping column permitting the shaft to be raised from a normal position of 43 1/2" to a maximum height of 55 1/2"
- Precision ball bearings are used throughout . . . in the jackshaft, motor couplings, hand pieces and motors
- Multi-speed models have readily adjustable belt tensioner
- Six flexible shaft assemblies may be had for all types of work

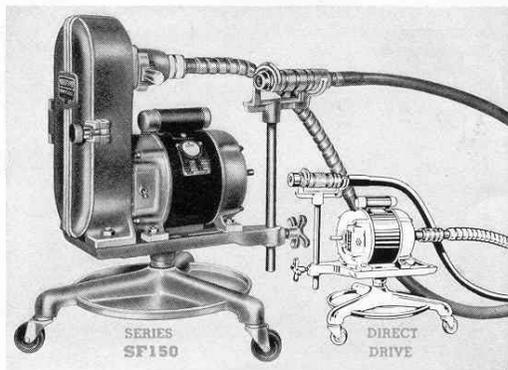

TOTAL PRICE INCLUDES EITHER HIGH OR LOW STAND PULLEY HOUSING, JACKSHAFT, SHAFT ASSEMBLY AND MOTOR

High Model No.	Low Model No.	Shaft Assembly		Motor	For High & Low Models	Total Price High Model	Total Price Low Model
		For High & Low Models					
SF-155A	SF-150A	SF-90	1 1/8"	KEB7X	3/4" H.P.	\$47.15	\$158.45
SF-155B	SF-150B	SF-91C	1 1/2"	KEB7X	3/4" H.P.	47.15	156.55
SF-155C	SF-150C	SF-84	1 1/8"	KEB5X	1/2" H.P.	34.10	127.90
SF-155D	SF-150D	SF-81	3/8"	KEB5X	1/2" H.P.	34.10	126.65
SF-155E	SF-150E	SF-120	1 1/8"	KEB3X	1/2" H.P.	28.30	102.10
SF-155F	SF-150F	SF-124A	1 1/4"	KEB3X	1/2" H.P.	28.30	100.85

If any of the above portable models are wanted for direct drive deduct \$16.55 and order by model number above adding the letter M to model number, i. e.: If SF-150D is wanted for direct drive order SF-150DM. This number will include the motor coupling.

Casings of W-T heavy shafts are made of four layers. The inner layer is tempered steel wire covered with an interlocking layer of mild steel. Next a layer of bronze to prevent elongation. Over all is a layer of soft rubber.

W-T cores are made of several layers of steel piano wire wound transversely for utmost strength. Ferrules are ground on centers for concentricity and have milled keyways to permit the core to float between handpiece and coupling.

The two heavier handpieces have tapered adapters for 1/2" bores, adapter for Jacob's drill chuck and 1/4" and 3/8" collet chuck. The high speed handpiece has a built-in 1/4" and 3/8" collet chuck.

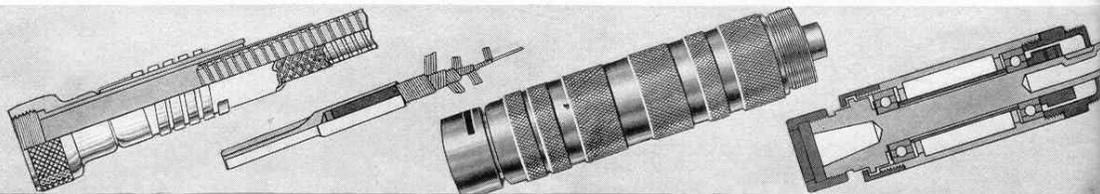

FOR HEAVY AND HIGH SPEED WORK

FLEXIBLE SHAFT MACHINES

SPECIFICATIONS (SF150 and SF155 Series)

HEIGHT: Overall in normal position 43½", with motor and shaft assembly raised to maximum 55½" for high model . . . low model 22".

TRIPOD STAND: Stand, motor table and belt housing are made of cast-iron. The belt housing cover is hinged for convenient speed changes.

SPEEDS: 1250 to 9500 R.P.M. with 3450 R.P.M. motor. Direct motor drive provides 3450 R.P.M. only.

MOTORS: ½, ½ and ¾ H.P. for direct or multi-speed drive. Motors are the capacitor type, ball-bearing equipped.

In the complete line of Walker-Turner flexible shaft equipment are models for practically every industrial and commercial need.

All Walker-Turner flexible shafting is designed, developed and manufactured in our own plant. Special types and sizes, if wanted in quantity, can be supplied. We also manufacture a wide variety of special drives for fuel pumps, speedometers and other light mechanical devices.

If you have some operation in manufacturing, or some drive problem in connection with your product where you think a flexible shaft might be used to advantage, just get in touch with our engineering service department.

UPPER BEARING ASSEMBLY: Has two dust-sealed ball bearings. This assembly is quickly adjustable (up or down) for belt adjustment.

MOTOR COUPLING: Available for direct drive.

HANDPIECES: Heavy and medium duty ball-bearing have interchangeable arbors for holding accessories with ½" bores, adapter for Jacobs drill chuck, and ¼" and ⅜" collet chuck. High speed handpiece has built-in collet chuck, ¼" and ⅜" capacity.

CASTERS: 3 large, hard rubber to make the machine readily portable.

SHIPPING WEIGHT: 120 lbs. for high model, 65 lbs. for low model.

SUSPENDED MODELS

These models are intended for overhead installation. The larger unit handles heavy production operations at 3450 R.P.M., while the lighter model (turning at 7600 R.P.M.) is used for high speed operations.

The bracket has a swivel eye-bolt rod and handpiece clamp and a swiveling motor base. The heavy model uses special Walker-Turner flexible shaft motors, while the high speed model requires the geared-head motor listed below. For high speed work use SF120, or SF124A.

SF10 Suspension bracket, \$18.75

GB7T ¾ H.P. 7600 R.P.M. geared motor 79.75

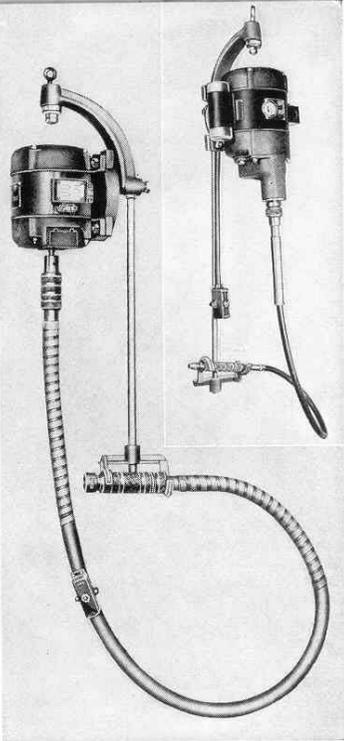

TO SELECT PROPER SHAFT ASSEMBLY

Because the demands made upon flexible shafts vary so widely these items are not included in machine prices. The proper assembly should be selected from those listed

below. On each line, reading from left to right, is listed one complete shaft assembly, its price, speed range, grinding wheel capacity and component parts.

Assembly		Core		Casing			Handpiece		Speed Range		Capacity	
No.	Price	No.	Diam.	Price	No.	Length	Price	No.	Price	From	To	Grinding Wheel
SF90	\$64.40	SF91	1 1/8"	\$15.65	SF91A	6'	\$20.65	SF56	\$28.15	1250	3450	7" x 1" x 1/2"
SF91C	62.50	SF91B	1 1/2"	13.75	SF91A	6'	20.65	SF56	28.15	1250	4000	7" x 3/4" x 1/2"
SF84	46.90	SF87	1 1/8"	11.90	SF83A	6'	13.15	SF85	21.90	1250	4775	6" x 1" x 1/2"
SF81	45.65	SF83	3/8"	10.65	SF83A	6'	13.15	SF85	21.90	1750	6500	5" x 1" x 1/2"
SF120	26.90	SF121	1 1/8"	4.40	SF121A	4'	8.15	SF115	14.40	3450	9500	4" x 3/4" x 1/2"
SF124A	25.65	SF121B	1/4"	3.15	SF121A	4'	8.15	SF115	14.40	3450	9500	3" x 1/2" x 1/2"

MOTOR COUPLING

SF55 Ball bearing fits ½", ¾", ¾" motor shafts. State size \$8.15

TOOL TRAY

SF45A For high models, \$7.20

JACOBS CHUCK

33B 1 1/8" - 1/2" cap. \$7.20

WHEEL GUARDS

SF9H For SF56 handpiece \$6.25

SF9M For SF85 handpiece \$6.25

HANDPIECE CLAMP

SF47A Holds handpiece rigidly in one position. \$3.70

ANGLE HEADS

SF125 For SF91A casing, \$21.90

SF125A For SF83A casing \$21.90

TILTING YOKE

SF53 Eliminates sharp bends, fits all models. \$6.20

7" FLEXIBLE DISC

SF2D Holds abrasive discs \$8.30
6 abrasive discs 1.90
SF4, 36 grit; **SF6**, 60 grit; **SF8**, 80 grit.



SF55

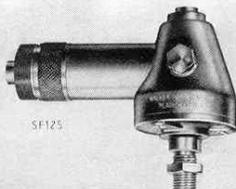
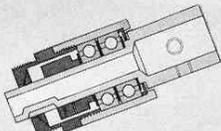

SF125

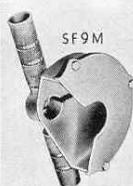

SF9M

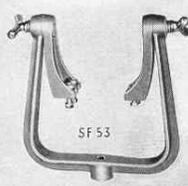

SF53

WITH WALKER-TURNER ECONOMIES

B575 7-INCH BENCH SAW

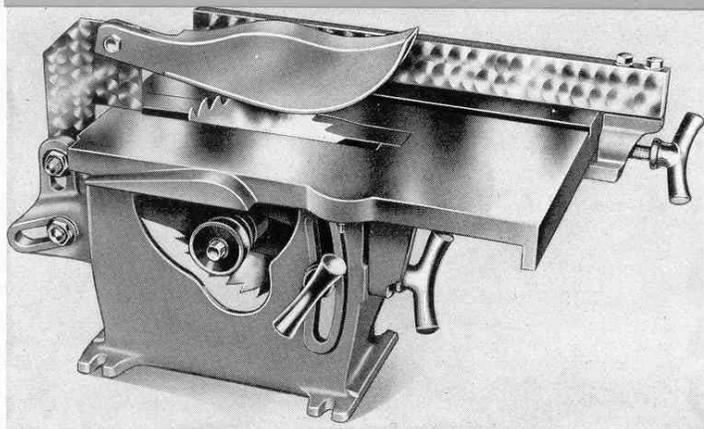

B575 7" bench saw, as shown including guard and splitter, steel rip fence and mitre gauge. Belt and motor pulley extra **\$18.15**

VB39 39" V belt..... **.95**

PV450 4" pulley for use with 1740 R.P.M. motor..... **.65**

B9 7" crosscut blade 1 1/2" bore **2.40**

B9R 7" rip saw blade 1 1/2" bore **2.40**

D55 5 1/2" dado outside saw, 2 used, each **2.20**

D55A Dado inside chipper used with D55..... **.80**

- 2 1/8" cut with a 7" blade . . . unusual capacity for a machine in this price class
- Latest type splitter with high grade guard, ordinarily available only on much more expensive machines
- Does ripping, crosscutting and dadoing at all angles
- Mitre gauge included regular equipment
- Solid steel rip fence and machined

- fence bracket have extra rigidity and should not be confused with flimsy ones that "give" and ruin accuracy
- The close tolerances observed in its manufacture are your assurance of extremely accurate work over a period of many years
- Its extreme popularity in many thousands of shops is another indication of the unusual value built into this machine

SPECIFICATIONS

TABLE: 14" x 10", machined gray iron, tilts to 45°. Has adjustable stop screws at 90° and 45° positions. Heavily ribbed on underside for rigidity and strength.

BEARINGS: Self-lubricating bronze carefully fitted.

SAW ARBOR: Raises and lowers, a very helpful feature when dadoing or grooving.

CAPACITY: Maximum depth of cut 2 1/8". Uses 7" diameter blades (1/2" bore).

THROAT: Removable for dadoing or sanding.

RIP FENCE: Solid steel machined bar. Has strong supporting table bracket, accurately machined.

SAW SPINDLE: Steel, ground to fine finish, 1/2" in diameter.

GUARD: Simple, efficient type furnished regular equipment.

SPLITTER: Located behind blade spreads saw kerf slightly, facilitating the sawing of green or damp lumber.

SHIPPING WEIGHT: 35 lbs.

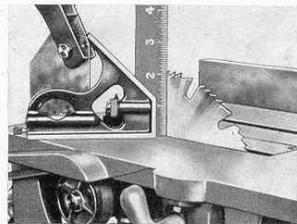

2 1/8" CUT • 7" BLADE

The design of this saw was so carefully worked out that, with the blade in top position, 2 1/8" stock can be sawed. The blade can be lowered below the table top, a conveniently located handle locks the arbor at any required position. A similar handle locks the table at various angles of tilt.

STURDY CONSTRUCTION

The frame, table, arbor and table brackets are simple, rugged pieces carefully machined to operate smoothly and efficiently. No flimsy parts to lose their alignment or break.

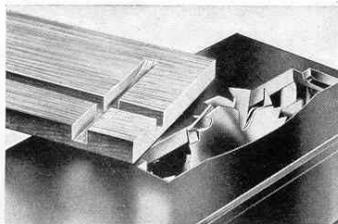

DADOING AND GROOVING

Dadoing and grooving are done easily and accurately on the "500" bench saw. The photograph, at left, shows an excellent example of dado work, done on this machine. The table insert and saw blade are removed and the dado head attached to the saw arbor in place of the saw blade. Width of cut is governed by the number of chippers used while depth of cut is determined by the vertical position of the arbor.

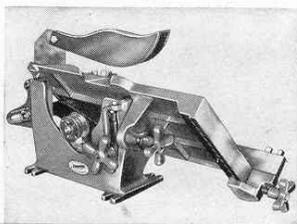

QUALITY FAR ABOVE ITS PRICE

L 5 4 0 GAP BED LATHE

L540 Gap Bed Lathe, as shown, including 34" V Belt and box wrench. Motor pulley extra.
\$25.40
PV4 4" 4-step V Pulley for motor **.90**

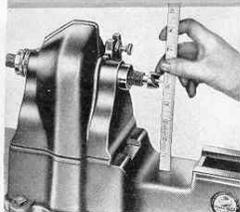
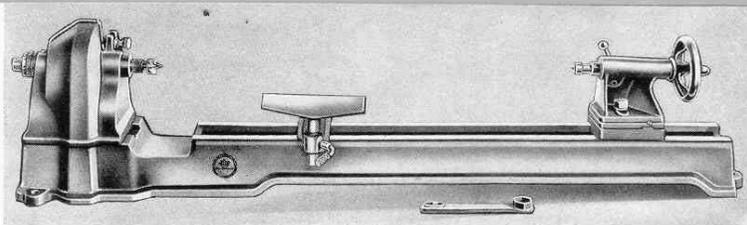

GAP BED FEATURE

This feature provides a distance from center of spindle to bed of 5", thus permitting discs up to 10" in diameter to be turned. The view above also shows the indexing pin at the rear of the head casting. It is used in conjunction with indexing holes in the pulley.

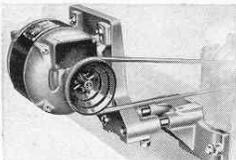

MOTOR BRACKET

This bracket attaches directly to the lathe bed. Speeds of 700, 1340, 2320 and 4200 R.P.M. are available with a 1740 R.P.M. motor and 4" 4-step pulley. Fits all lathes.

5L51 Direct drive motor bracket less pulley **\$4.00**

For a 16 speed motor bracket see **5L52** listed on page 32.

- The hollow head spindle is a feature ordinarily found only on much more expensive lathes
- No. 1 Morse Taper centers, the finest type of construction known to lathe manufacture
- The heavy cast-iron bed is strongly braced and the bed ways accurately machined
- Provision is made for metal turning. Chucks, compound slide rest and tools available to fit this model are shown on pages 34 and 35
- The head is designed so that it also functions as a belt guard
- Two selections of motor brackets are available. One provides the necessary four speeds for wood-turning, the other has sixteen speeds for metal turning

SPECIFICATIONS

BED: Gap-type providing extra capacity for face plate work. Cast-iron carefully machined 44" long, 3 1/2" high.

HEADSTOCK: Cast-iron machined to close tolerances. Fitted with indexing device for holding turnings stationary while being fluted or beaded.

TAILSTOCK: Gray iron casting accurately fitted. Has set-over for turning tapers, also immediate release for hand wheel.

SWING: At gap 10", over bed 8".

HOLLOW SPINDLE: In headstock. More expensive than solid spindle. Permits turnings of small diameter such as arrows to be slid through the spindle after turning. Outside diameter of spindle 3/4".

CAPACITY: Between centers 30 1/2", with extension bed (5L41) 14" additional capacity is obtained.

CENTER: Headstock has removable spur center with No. 1 Morse Taper. Tailstock has cup center for woodturning, also No. 1 Morse Taper.

TOOL RESTS: 6" standard, 18" available as an accessory.

PULLEY: Headstock pulley is 4", four step, cone type. 34" V belt supplied regular equipment.

MOTOR RECOMMENDED: 1/4 or 1/2 H.P., 1740 R.P.M. using 4" four step pulleys.

SHIPPING WEIGHT: 65 lbs.

METAL TURNING • FACE PLATE WORK

Soft steel, cast-iron, brass and other metals, as well as molded plastics and compositions are readily turned on this "500" lathe with the proper accessories. This view shows a cold rolled steel bar being turned. Universal and independent chucks, compound slide rest, lathe dog, special centers, steady rest and other metal turning accessories are shown on page 35.

In this operation the distinct advantage of the gap bed is apparent. This feature permits discs up to ten inches in diameter to be turned. Bases for floor lamps, and pedestals of various types can be turned in the normal position.

TURNS WOOD, METAL AND PLASTICS

Turning is an extremely fascinating diversion whether done for pleasure or for profit. To see a piece of wood, metal or molded plastic take form under the contact of the cutting tool or chisel and change rapidly into a series of well-proportioned curves, shoulders and beads is a rare treat.

The "500" lathe is one of the most popular home-workshop lathes made yet its accuracy and durability have won for it a place in many service stations and factories where it is used on various light jobs.

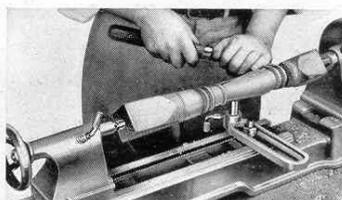
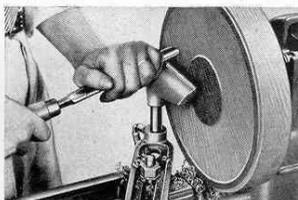
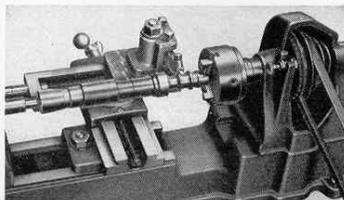

URNS WOOD, METAL AND PLASTICS

J505 14" JIG SAW

SPECIFICATIONS

TABLE: Close-grained gray iron, 9" x 9", tilts to 45° on double trunnion. Has accurate indicator.

CAPACITY: Blade to frame, throat, 14" . . . upper vise to table 1½".

BEARINGS: Bronze bearings throughout.

FRAME: One piece, rigid cast iron, strong tubular construction.

VICES: Can be moved one quarter turn so sawing may be done from sides.

DRIVING MECHANISM: Reciprocating type, quick, smooth and dependable.

Splash system of oiling.

BLOWER: Plunger type located in head. Keeps lines clear at all times.

HEIGHT OVERALL: 19½".

LENGTH OVERALL: 21".

MOTOR REQUIRED: ¼ or ½ H.P., 1740 R.P.M.

SHIPPING WEIGHT: 34 lbs.

FINE BALANCE ASSURES MINIMUM VIBRATION

The DRIVER 14" Jig Saw operates quieter, cuts better, is easier to handle and requires no "time out" for repairs. Its tubular cast iron frame and finely balanced drive mechanism keep vibration down to a minimum.

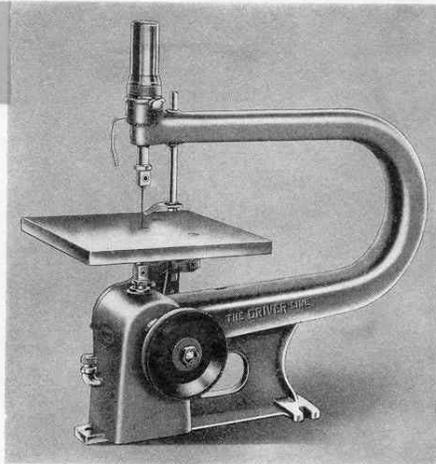

J505 14" Jig Saw, as shown (without belt or motor pulley) \$19.60

VB42 42" V-Belt 1.15

PV25 2½" V-Pulley50

5J4 Large blade vises 1.95

MJ30X Fine blade vises (for replacement) pair 2.90

TABLE TILTS TO 45°

The sturdy, double trunnion mounting of the table is a feature that gives added stability to the table. Note how clearly the angle of tilt is indicated, how simple and strong all parts are. The driving mechanism is totally enclosed in the oil-tight crank case. No dust or dirt can get in.

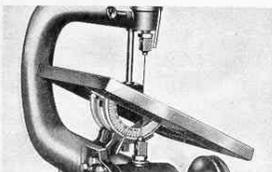

BN560 10" BAND SAW

SPECIFICATIONS

CAPACITY: Blade to frame 10" . . . upper guide to table 4".

FRAME: Cast-iron, heavily reinforced.

TABLE: Machined cast-iron, 10" x 10", tilts to 45°. Wood extension increases width to 15".

WHEELS: Disc type, balanced 10" in diameter, fitted with rubber facings to protect blade.

BEARINGS: Wheel bearings are bronze sleeve type.

GUIDES: Upper guide roller is ball-bearing.

GUARDS: Wheel guards of soft metal prevent injury to blade in case of accidental contact. Mounted independently of each other, held in place by hand screws. Small guard above upper guide keeps blade covered at that section.

TENSIONER: The blade tensioner moves on two ground steel rods, has a coil spring in housing to absorb shocks.

HEIGHT OVERALL: 26½".

MOTOR RECOMMENDED: ¼ H.P., or ½ H.P., 1740 R.P.M.

SHIPPING WEIGHT: 61 lbs.

A QUALITY TOOL

Thousands of craftsmen are enthusiastic about this 10" Band Saw. Extra attention to detail is apparent in every feature. With a high quality band saw such as this available at so reasonable a cost, no workshop should be without one. The full-protection guards, heavy cast-iron frame, balanced disc wheels, ball-bearing guide roller and table extension are features every craftsman will recognize as proof of finest quality.

WOODWORKING BLADES FOR 10" BAND SAW			
Cat. No.	5BN51	5BN52	5BN53
Width	½"	¾"	1"
Length	62"	62"	62"
Price	\$1.60	\$1.60	\$1.60

TABLE TILTS TO 45°

The table tilts evenly and smoothly on frame, locks rigidly in position with hand wheel. Graduated quadrant indicates degree of tilt.

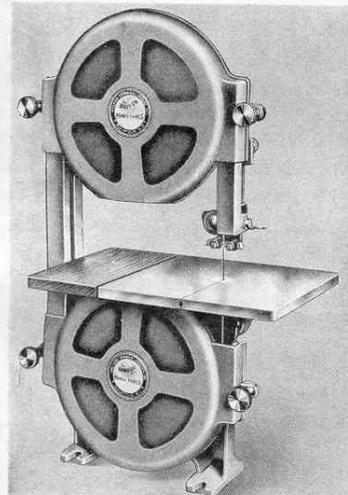

BN560 10" Band Saw, as shown complete with all guards and wood insert between table and frame. (Belt and motor pulley not included) \$31.20

VB44 44" V-Belt 1.15

PV175 1¾" V-Pulley50

EL5 Flexo Lamp 2.55

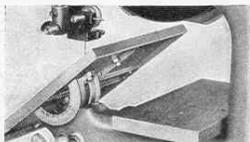

APPARENT IN EVERY TOOL

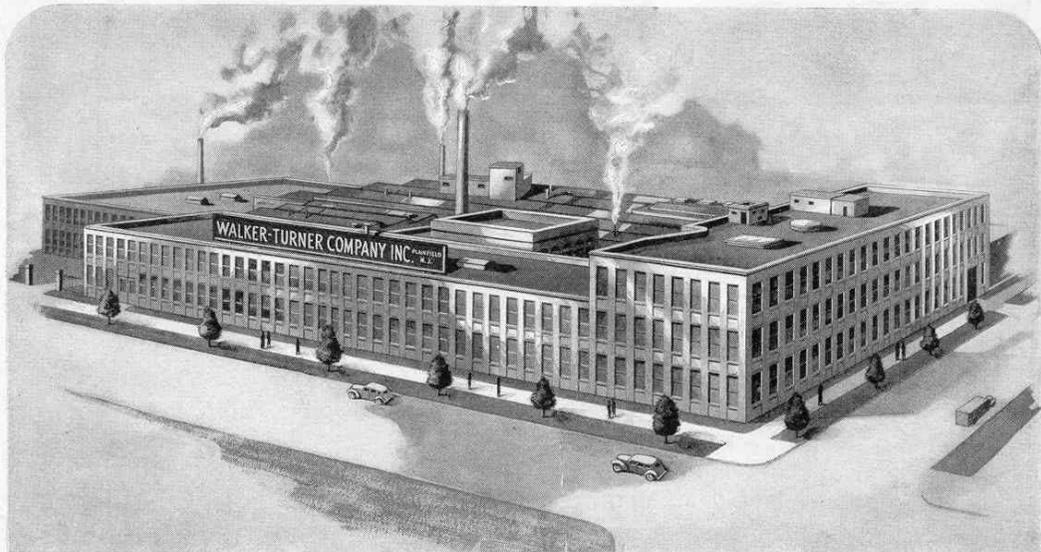

Behind Walker-Turner Machines . . .

is an efficient organization of trained specialists . . . men who know their jobs and like their work. All the resources of a modern plant with over 150,000 square feet of floor space are devoted exclusively to the development and manufacture of Walker-Turner machines.

Into the design and construction of Walker-Turner equipment goes the vast experience gained in manufacturing and selling more than a half-million modern and efficient light power tools. These machines . . . in every quarter of the globe . . . in every size of plant . . . are giving their owners economical, dependable service. Thousands have expressed their unqualified approval of Walker-Turner advanced design, precision manufacture and genuine, all-round value.

There are savings in store for you . . . with Walker-Turner machines. Let your local distributor explain how these modern machines function . . . how they can speed production and save money in your shop.

WALKER-TURNER CO. INC.
PLAINFIELD, NEW JERSEY, U. S. A.
EXPORT OFFICE • 75 WEST ST., NEW YORK CITY